

Verizon Wireless

N e t w o r k E x t e n d e r

User Manual

Please read this manual before operating your device, and keep it for future reference.



Intellectual Property

All Intellectual Property, as defined below, owned by or which is otherwise the property of Samsung or its respective suppliers relating to the SAMSUNG Device, including but not limited to, accessories, parts, or software relating there to (the "Network Extender"), is proprietary to Samsung and protected under federal laws, state laws, and international treaty provisions. Intellectual Property includes, but is not limited to, inventions (patentable or unpatentable), patents, trade secrets, copyrights, software, computer programs, and related documentation and other works of authorship. You may not infringe or otherwise violate the rights secured by the Intellectual Property. Moreover, you agree that you will not (and will not attempt to) modify, prepare derivative works of, reverse engineer, decompile, disassemble, or otherwise attempt to create source code from the software. No title to or ownership in the Intellectual Property is transferred to you. All applicable rights of the Intellectual Property shall remain with SAMSUNG and its suppliers.

Samsung Telecommunications America (STA), LLC

Headquarters:	Customer Care Center:
1301 E. Lookout Drive	1000 Klein Rd.
Richardson, TX 75082	Plano, TX 75074
Toll Free Tel:	1.888.987.HELP (4357)

Internet Address: <http://www.samsungusa.com>

© 2009 Samsung Telecommunications America, Samsung LLC. Samsung is a registered trademark of Samsung Electronics America, Inc. and its related entities.

Do you have questions about your Samsung Device?

For 24 hour information and assistance, we offer a new FAQ/ARS System (Automated Response System) at:

www.samsungtelecom.com/support

EP68-00359A

Printed in Korea

Disclaimer of Warranties; Exclusion of Liability

For more information, refer to "*Warranty Information*" on page 25.

Table of Contents

Section 1: Getting Started2

Introduction	2
What's In the Box?	2
System Requirements	3
Quick Setup	3

Section 2: Using Your Device6

Additional Setup Information	6
Activating Your Verizon Wireless Network Extender	8
Getting Help	8
Verizon Wireless Network Extender Basics	9
Components - Front View	9
Components - Rear View	10
Features	12

Section 3: External GPS Antenna13

Antenna Installation	13
----------------------------	----

Section 4: Troubleshooting16

Section 5: Important Safety Information19

General Precautions	19
Using Your Network Extender Near Other Electronic Devices ..	20
Radio Frequency (RF) Energy	20
Knowing Radio Frequency Safety	20
FCC Radio Frequency Emission	21
User Guide Proprietary Notice	24

Section 6: Warranty Information25

Standard Limited Warranty	25
End User License Agreement for Software	28
Open Source Announcement	31
GNU GENERAL PUBLIC LICENSE	33
NO WARRANTY	38
GNU GENERAL PUBLIC LICENSE	40
TERMS AND CONDITIONS FOR COPYING, DISTRIBUTION AND MODIFICATION	42
NO WARRANTY	48
Apache License	49
BSD 2.0 License	53
OpenSSL	54
APPLE PUBLIC SOURCE LICENSE	55
Index	64

Section 1: Getting Started

Introduction

Congratulations on the purchase of your Verizon Wireless Network Extender.

Your purchase of this Network Extender enhances the wireless telephone service that you and your family will receive while in your home or home office.

This User Guide introduces you to the Verizon Wireless Network Extender service and all the features of your new device. It includes the following sections:

- Getting Started
- Using Your Device
- External GPS Antenna
- Troubleshooting
- Important Safety Information
- Manufacturer's Warranty

Throughout this guide, you'll find tips and techniques that help you make the most of your new device and service.

It is important that you read each section and note any special requirements. However, if you'd like to get right to a specific feature, simply locate that section in the Table of Contents and go directly to that page. Follow the instructions in that section, and you'll be ready to use your Network Extender in no time.

Note: Due to updates in software and procedure, this printed guide may not be the most current version for your Network Extender. Visit www.verizonwireless.com/support to access the most recent version of this guide.

What's In the Box?

- Network Extender
- Ethernet Cable
- Power Supply and Power Cord
- External GPS and antenna cable
- User Guide
- Quick Start Guide

System Requirements

- An always-on broadband Internet connection with a minimum speed and available bandwidth of 300 kbps.

Note: Satellite, MiFi or wireless connections are not supported.

- An available Ethernet (LAN) port on either your broadband modem or a router connected to the modem.

Note: If you are connecting your Verizon Wireless Network Extender to a router, please ensure it supports Virtual Private Networking (VPN). Although most routers support this functionality, refer to your router's product documentation to confirm compatibility.

Quick Setup

Setting up service on your new Verizon Wireless Network Extender is fast and easy. This section outlines the procedures needed to quickly set up the Network Extender.

Note: You may also visit www.verizonwireless.com/b2c/store/accessory?action=gotoSetup to view the online setup and usage tutorial. Follow the onscreen prompts.

1. Confirm your package contains all components.
2. Review the "Important Safety Information" on page 19 before installing the Network Extender.

3. Make sure that both your router and your Internet broadband modem are functioning properly. Refer to your particular product's documentation for more information.

Note: A router with at least one free Ethernet port is required to connect the Network Extender.

4. Place the Network Extender near a window in a central location.
 - For best results, place the Network Extender in an elevated location, such as the top of a bookshelf or tall cabinet.

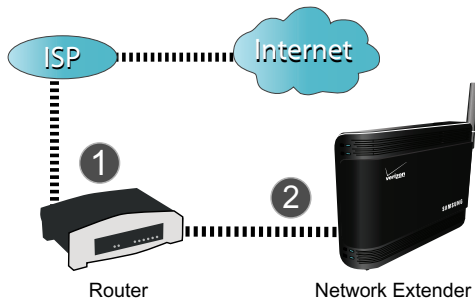

5. Connect one end of the included Ethernet cable to an open LAN port on the router (1) and connect the other end to the WAN port located at the rear of the Network Extender (2).

Note: Plug the Ethernet cable into the Network Extender before connecting the power supply.

6. Plug the power supply connector into the DC 12V power port located at the rear of the Network Extender (3).
7. Insert one end of the power cord into the power supply and then plug the other end into an available power outlet (4).

Warning! Insert the plug into the power outlet last. Failure to do so could cause an electrical short or power surge to the Network Extender.

Note: The use of a surge protector is recommended for the Verizon Wireless Network Extender.

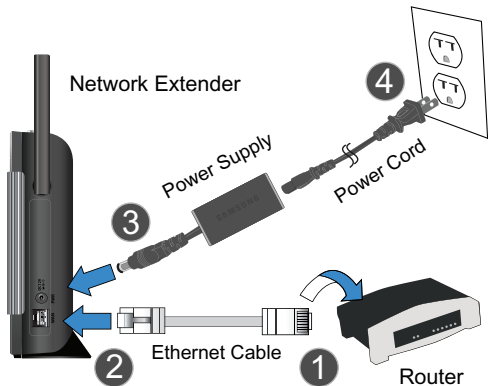

8. Confirm that the front LEDs are illuminated as indicated below:

- **Power LED:** should be a continuous blue light, indicating that the Network Extender is receiving power.

No illumination indicates there is an issue with the power supply or power connector.

- **System LED:** should be a continuous blue light, indicating that the Network Extender is properly communicating with the Verizon Wireless network. Blinks red while establishing an initial network connection. Continuous red indicates an abnormal condition.

- **GPS LED:** should be a continuous blue light, indicating that the Network Extender has locked onto a valid GPS signal. If the GPS LED is red, the internal antenna may not be able to detect a GPS signal, and installation of the external GPS antenna might be necessary.

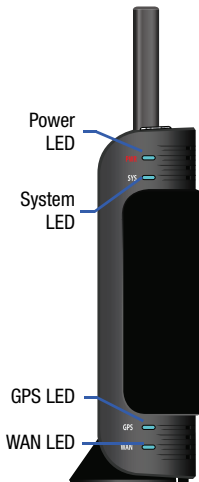

- **WAN LED:** should be a steady blue light, indicating that the Network Extender has detected a valid Ethernet connection. A blinking blue LED indicates data communication.

Note: Allow 3 - 5 minutes for the Network Extender to complete the startup sequence and detect both its connections and available communications. The first time the Network Extender is used, it may take as long as one hour for the initial GPS acquisition. If the GPS LED is still red after one hour, relocate the GPS antenna to receive a stronger signal. See "Antenna Installation" on page 13.

9. Confirm your setup was successful and your Network Extender is functioning properly:

- Confirm that all the LEDs are blue.
- Dial #48 from your Verizon Wireless phone and listen for the "You are on the Network Extender" message.

Verizon Wireless strongly recommends you access your Network Extender account online via **My Verizon** on verizonwireless.com and set up a list of priority users.

- You may want to include all members of your household that have a Verizon Wireless phone.
- If you do not choose to manage the access to your Network Extender, anyone within range of your Network Extender will be able to use your Network Extender.

Section 2: Using Your Device

Additional Setup Information

Getting started with your new Verizon Wireless Network Extender is easy. This section walks you through an overview of the product, package contents, activation, and how to contact Verizon Wireless for assistance with your service and your Network Extender.

The Verizon Wireless Network Extender is used within your home or home office to extend your Verizon Wireless coverage area through an existing Internet broadband connection.

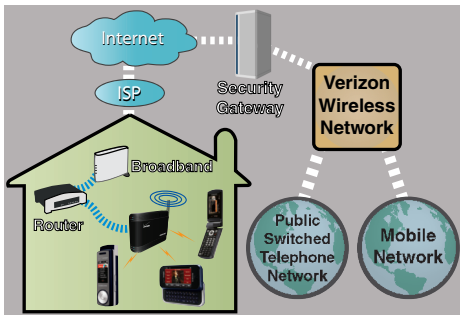

About the size of a traditional wireless access point (WAP), the Network Extender facilitates the delivery of cellular traffic through the Internet to the Verizon Wireless network, which then routes the signal to the desired party.

- **Number of Users:** A maximum of **three (3)** phones can connect to the Verizon Wireless Network Extender at any one time.
 - The first three callers to initiate or receive a call will connect to the Network Extender. Additional users who make or receive a call while all Network Extender channels are in use are redirected to the nearest compatible cell tower (if available).
 - As each caller ends a call, that channel then becomes available for another user to initiate (or receive) a new call.

Note: The Network Extender can be managed to ensure Verizon Wireless phone numbers you authorize will always enjoy priority access to the Network Extender network. For more information, see "Quick Setup" on page 3, or view the online Setup tutorial at: <http://www.verizonwireless.com/b2c/store/accessory?action=gotoSetup>

- **Manage Access:** Authorized account users can manage access settings for their Verizon Wireless Network Extender by logging into My Verizon at www.verizonwireless.com.
 - Up to 50 Verizon Wireless cell phones can be registered.

– When the Network Extender is set to managed access mode, unauthorized users are redirected to the nearest compatible cell tower wherever possible.

- **Verify on Network Extender:** Users can verify that they are on the Verizon Wireless Network Extender network by dialing #48 (and receiving an audio announcement). You will also hear a short double tone on your wireless phone when making or receiving a call while on the Network Extender network. The tone is played at the beginning of the call.

Note: A fourth channel, open to all callers, is always reserved for emergency (E911) calls.

- **Connect to the Network Extender:** In order to establish an initial connection to the Network Extender network, your Verizon Wireless mobile phone needs to move within close proximity (approximately 15 feet) of the Network Extender unit.
- **Calling on Network Extender:** After connecting to the Network Extender network, you can move within a broader perimeter while remaining under Network Extender coverage (approximately 40 feet). Refer to www.verizonwireless.com/support for additional details.
- **Ranges Will Vary:** Both the coverage area required to establish an initial connection and the broader coverage area of the Network Extender cannot be guaranteed and may vary due to environmental factors, such as physical structures and the strength of the external cell tower coverage.

The table below outlines bandwidth requirements based on the number of active callers:

Simultaneous Callers	Download Speed Requirement	Upload Speed Requirement
1 caller	40 kbps	40 kbps
2 callers	80 kbps	80 kbps
3 callers	120 kbps	120 kbps

The Network Extender maximizes wireless phone utility within a small area by not only providing better voice quality, but by also allowing you to use this new service without any enhancements to your existing Verizon Wireless mobile phones.

By utilizing a built-in GPS antenna, the Network Extender is capable of maintaining exact network timing updates and providing E911 services with an accurate location.

- The current GPS location (provided by the internal antenna) is used to help the Network Extender quickly locate GPS satellites for faster GPS acquisition.

- The external GPS antenna (provided with your Verizon Wireless Network Extender) allows you to place the Verizon Wireless Network Extender further from a window and run the antenna to an area with stronger GPS reception.

Warning: You may not be able to make 911 calls in the event of an electrical power outage, broadband connection failure, or other service disruption outside of the Verizon Wireless network coverage area. 911 services may be limited in areas outside of the Verizon Wireless network coverage area. Not all public safety answering points have location-based E911 technology. Always be prepared to report your location to the 911 operator when placing an emergency call. Mobile phones operate using radio signals which cannot guarantee connection in all conditions.

Activating Your Verizon Wireless Network Extender

Your Network Extender should already be activated. If it is not activated, please call Verizon Wireless Customer Service at **(800) 922-0204** or ***611** from your Verizon Wireless mobile phone and select the option for technical support.

Note: The Network Extender must be activated for use on the Verizon Wireless network before setup. It will not work unless it has been activated.

Should you need to activate your Network Extender, you will be asked to provide the following information:

- Primary Wireless Phone Number or Verizon Wireless Account Number (located on your Verizon Wireless billing statement)
- Account Password
- MAC ID of the Network Extender found on the sticker affixed to the device.

Getting Help

Note: In order to establish an initial connection to the Verizon Wireless Network Extender network, your mobile phone needs to move within close proximity of your Network Extender unit. After connecting to the network, you can move within a broader perimeter while remaining under Network Extender coverage. Refer to www.verizonwireless.com/support for additional details.

Note: Both the coverage area required to establish an initial connection and the broader coverage area of the Network Extender cannot be guaranteed and may vary due to environmental factors, such as physical structures and the strength of external cell tower coverage.

Reaching Verizon Wireless Customer Service

You can reach Verizon Wireless Customer Service in a number of ways:

- Call us toll free at **(800) 922-0204** or ***611** from your Verizon Wireless mobile phone.
- Visit the support pages at www.verizonwireless.com/support.

Verizon Wireless Network Extender Basics

- Components (page 9)
- Features (page 12)
- Maintenance Notes (page 12)

Your Network Extender is packed with features that expand your ability to stay connected to the people and information important to you. This section will guide you through the basic features and functions of your Verizon Wireless Network Extender.

Components - Front View

In addition to a wireless antenna, the Network Extender has four LED lights that are used to indicate the device connectivity status.

- **Wireless Antenna** provides omnidirectional transmission and reception of signals between the Network Extender and communicating Verizon Wireless mobile phones. The wireless antenna rotates 360 degrees.
- **Power LED (PWR)** indicates the power status.
- **System LED (SYS)** indicates the status of Network Extender connectivity to the Verizon Wireless network.
- **GPS LED** indicates the GPS connection status.

Note: If the unit's GPS signal strength is weak (due to location), it is recommended that you either move the Network Extender near a window or install the external GPS antenna. For more details, see "External GPS Antenna" on page 13.

Note: GPS antenna receives signals from Global Positioning System satellites and uses them to obtain time and location information.

- **WAN LED** indicates the status of the Ethernet connection.

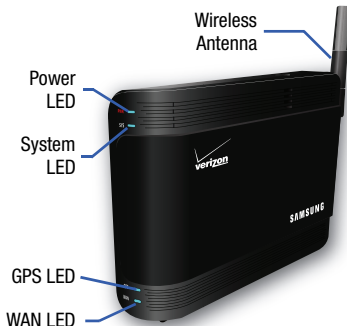

LED	Function	Description
PWR	Power	<ul style="list-style-type: none"> • Solid blue: normal • No light: abnormal
SYS	System connected	<ul style="list-style-type: none"> • Solid blue: normal • Solid red: abnormal
GPS	GPS signal	<ul style="list-style-type: none"> • Solid blue: normal (GPS is received) • Blinking blue or red: while searching for GPS • No light: abnormal (GPS signal cannot be received, the external GPS antenna is required)
WAN	WAN (Ethernet) connection	<ul style="list-style-type: none"> • Solid blue: normal • Blinking blue: data communication • No light: abnormal

Components - Rear View

The rear of the Network Extender provides access to the WAN port, power port, and external GPS antenna.

1. **GPS Antenna Port** slides to provide access to the external GPS antenna for removal and relocation.
 - A red GPS LED indicates a GPS signal could not be detected using the internal GPS antenna. The external GPS antenna should be connected. See "External GPS Antenna" on page 13.
2. **Heat Vents** provide passive ventilation for the Network Extender and allow for dissipation of internally generated heat.

Note: The Network Extender needs to remain vertical and in a well-ventilated location. The vertical position allows proper air flow to the internal components.

3. **DC 12V Power Port** provides power to the Network Extender when connected to the AC power supply and cord (included).

Warning!: Only use the provided power cord and supply. Using any other power source may damage the Network Extender.

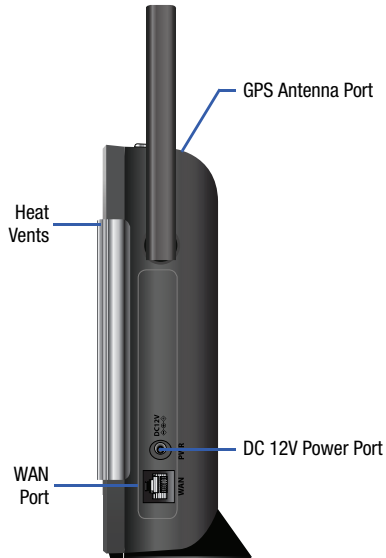

4. **WAN Port** allows you to connect the Ethernet cable provided to establish communication between the Network Extender and your broadband router. This connection port is then used to transmit voice and data through the Internet to the Verizon Wireless network, which then authenticates the Network Extender and allows communication with wireless phones.

- If the corresponding WAN LED does not illuminate, this indicates that although an Ethernet cable is connected, no communication is occurring through either your router or your ISP Internet connection (DSL, fiber optic, cable, etc.).
- Please make sure your broadband connection is active and functioning properly. Contact your Internet Service Provider if the problem persists.

Features

The following list highlights some of the Network Extender's features:

- The Network Extender enables users to easily install and configure the system by connecting to an existing broadband network.
- To prevent unauthorized users from accessing the Network Extender and diminishing your available bandwidth, you have the option to restrict the use of your Network Extender by logging into My Verizon at www.verizonwireless.com.
- The Network Extender is a Plug & Play device that can be installed to automatically provide enhanced wireless telephone service in a home or small office without having to change your existing mobile phone.
- The Network Extender utilizes a GPS receiver to get both timing and unit location information. In case of a weak GPS signal, install the external GPS antenna and locate it near a window to receive a stronger signal.

Note: Certain Verizon Wireless services are not compatible with the Network Extender, refer to www.verizonwireless.com/support for details.

Maintenance Notes

These notes should be carefully reviewed before using the Network Extender:

- See "General Precautions" on page 19.
- Only connect the Network Extender's power plug to a 110–125 VAC outlet.

Note: The use of a surge protector is recommended.

- When cleaning the Network Extender, first unplug the connector from the power outlet. Do not clean the Network Extender using chemical solvents or detergents, but with an anti-static cleaning pad.
- If the Verizon Wireless Network Extender is connected to a Wi-Fi router, ensure that the unit is placed at least 2 feet away from the router (to avoid interference).
- Do not obstruct the heat vents by blocking the openings or covering the Network Extender.
- Remove the Network Extender's power connector from the power outlet if the device will not be used for an extended period of time.

Section 3: External GPS Antenna

If your Verizon Wireless Network Extender cannot receive a Global Positioning System (GPS) signal, it may be necessary to improve the reception by installing and then positioning the external GPS antenna. This section outlines the installation and relocation of this GPS antenna.

Antenna Installation

In some cases, you may find that because of its current location, the Network Extender's GPS antenna may not be able to properly receive an active GPS signal. If a stable GPS signal is not detected, as indicated by the red GPS LED, you will need to install the GPS antenna cable as explained in this section.

Without a valid GPS signal, the Network Extender cannot function properly, and calls will be redirected to the nearest compatible cell tower.

Warning! Use only the GPS antenna supplied with your Verizon Wireless Network Extender.

When positioning the GPS antenna, ensure that it is:

- Installed in a horizontal position.
- Adjacent to a window and in an open area. This ensures clear reception of the GPS signal.

Note: GPS signal strength is greatly reduced when passing through walls or other hard surfaces.

To connect the GPS antenna to the Network Extender, follow these steps:

1. Turn off the Network Extender.
2. Rotate the antenna down to provide access to the GPS antenna's protective cover.

Note: The GPS antenna receives signals from Global Positioning System satellites and uses them to obtain time and location information.

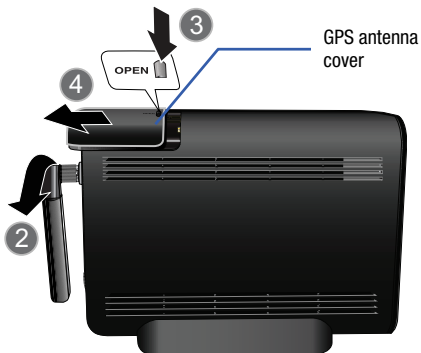

3. Firmly press down on the Open groove (top of station).
4. Slide the protective cover back to expose the rectangular GPS antenna.
5. Use a blunt tool (such as a coin) to carefully pry the GPS antenna away from the Network Extender, in the same direction as shown in step 4.
6. Remove the GPS antenna from its compartment.

7. Connect and secure the GPS antenna to the end of the provided GPS cable labeled "Connect to GPS Antenna."
8. Connect and secure the terminal end of the same mini-coax cable to the port on the Network Extender (within the GPS antenna compartment).

Warning! Do not force the connector into the GPS antenna port as this can damage the connector.

9. Replace the cover on the station. Verify the cable is threaded through the opening on the cover.
10. Rotate the antenna back up to its original position.

Tip: Place the antenna near a window where the GPS signal is strongest.

Warning! Do not use duct tape to secure the GPS antenna to its new location.

Tip: You can use double-sided tape to secure the bottom of the GPS antenna to its new location.

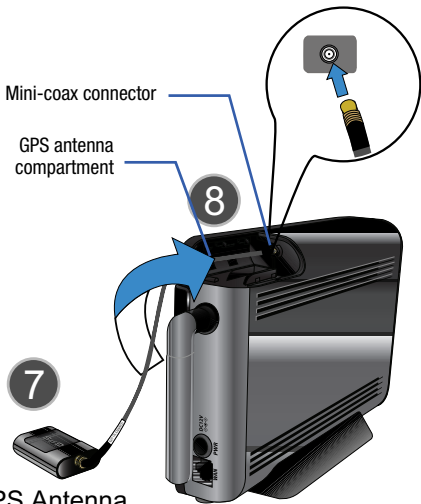

GPS Antenna

11. Power on the Network Extender to allow the detection of both the external antenna connection and an available GPS signal.

Note: If a GPS signal cannot be detected, remove the GPS antenna and place it in a new location to receive a stronger signal. This new location should be located close to a window.

Section 4: Troubleshooting

Now that you've been given an overview of the Verizon Wireless Network Extender, some situations might arise where you'll need additional usage or connection help. This section provides some troubleshooting tips and techniques.

For more information, please visit us online at www.verizonwireless.com/support.

- **My Power LED is not illuminating.**

- Make sure that one end of the power cord is securely connected to an active outlet and that the other end is properly connected to the power supply.
- Make sure the power connector is securely inserted into the rear DC 12V port on the back of the Network Extender.

- **My GPS LED is not illuminating blue even after a few minutes.**

Note: The first time the Network Extender is used after installation or after relocation, it can take up to one hour to acquire a GPS connection.

- The GPS antenna cannot obtain a signal.
- If possible, move the Network Extender to a location with fewer surrounding obstructions. The new location should be in an open area and closer to a window, if possible.
- If the preceding fails, remove the power cord from the wall outlet for at least 10 seconds.

- Reconnect the power connector to the DC 12V port and plug the power cord into the wall outlet. This allows the Network Extender to re-initiate its startup sequence where it detects the Ethernet connection, GPS signal, and communication with the Verizon Wireless network.
- If relocation does not produce a GPS signal, uninstall the GPS antenna from the Network Extender and relocate it to receive a stronger signal.

- **My WAN LED is blue but I cannot place a call via my Verizon Wireless Network Extender.**

- Check that the router is communicating properly with your ISP. The Internet activity LED on your router should be blinking. For further router troubleshooting tips, please review the router manufacturer's printed or online documentation.

- **My System LED is solid red.**

- A red System LED indicates a system error was detected and is symptomatic of a communication problem with the Verizon Wireless network.
- Confirm your Network Extender was activated at time of purchase. If your Network Extender has not already been activated, call Verizon Wireless Customer Service at (800) 922-0204 or *611 from your Verizon Wireless mobile phone and select the option for technical support.
- Before contacting the Verizon Wireless Customer Service Center, confirm the following:
 - Is your WAN LED illuminating blue?
 - If it is not, then there may be a communication problem between your Network Extender and the router.
 - If the WAN LED is illuminating blue, then check that the router is communicating properly with your ISP. The Internet activity LED on your router should be blinking. For further router troubleshooting tips, please review either the router manufacturer's printed or online documentation.
 - Is the GPS LED illuminating blue? If it is not, the Network Extender might not be receiving a GPS signal. Inability to receive a GPS signal can result in the Network Extender failing to validate your account information and network timing, which then prevents usage and reroutes you back to the nearest compatible cell tower. If this is the problem, install the external GPS antenna. See "External GPS Antenna" on page 13.

- **The Network Extender seems to be getting too hot.**

- Make sure there is nothing blocking the heat vents located along the side of the Network Extender.
- It is recommended that the Network Extender be located in a well-ventilated open area at least 12 inches from any surrounding hot surfaces. It is not recommended that the Network Extender be installed in a cabinet or other enclosed location.

- **How can I manage access to my Network Extender?**

- You have the option to manage priority access settings for your Network Extender to specified numbers by logging into My Verizon at www.verizonwireless.com. A maximum of 50 authorized Verizon Wireless callers can be registered.
- When the Network Extender is set to open access, the first three callers detected within the device's area are given access to place or receive calls through the Network Extender. Your Verizon Wireless Network Extender is set to open access by default.
- Anyone else who then initiates a call while all Network Extender channels are occupied is redirected to the nearest compatible cell tower when available.
- When unauthorized callers (callers not on your managed access list) within range of the Network Extender attempt to place a call, they are automatically redirected to the nearest compatible cell tower.
- If a handoff to the nearest compatible cell tower is not possible and all channels are not in use, one channel may be available for an

unauthorized user to access. Callers on the managed access list are always given priority access to the Network Extender.

Note: Both authorized and unauthorized callers may see more service bars on their Verizon Wireless handset due to their proximity to the Verizon Wireless Network Extender.

Note: A fourth channel is always reserved for emergency (E911) calls to any user within range of the Network Extender.

Section 5: Important Safety Information

This user guide contains important operational and safety information that will help you safely use your Network Extender.

General Precautions

There are several simple guidelines to operating your Network Extender properly and maintaining safe, satisfactory service.

- Avoid exposing your Network Extender to rain or liquid spills. If your device does get wet, immediately turn the power off and remove the power connector.
- Do not operate the Network Extender in an extremely dusty or humid environment.
- Avoid placing the Network Extender near radiators or other heating sources.
- Do not obstruct the heat vents by blocking the openings or covering the Network Extender, and do not operate it in a confined space.
- Avoid locating the Network Extender where it could be exposed to direct sunlight for prolonged periods.
- Do not connect the Network Extender to a power strip containing an excessive number of other devices. Refer to the documentation that came with your power strip for capacity information.
- Do not disassemble the wireless antenna.

- Do not attempt to open the Network Extender or power supply, or disassemble either component, or remove the wireless antenna. You run the risk of electrical shock and/or burn and voiding the limited warranty. No user-serviceable parts are located within the Network Extender enclosure.
- If the Network Extender will not be used for a prolonged period, remove the power cord from the AC outlet.
- Although your Network Extender is quite sturdy, it is a complex piece of equipment and can be broken. Avoid dropping, hitting, bending, or sitting on it.
- Any changes or modifications to your Network Extender not expressly approved in this document could void your warranty for this equipment and void your authority to operate this equipment.

Warning: You may not be able to make 911 calls in the event of an electrical power outage, broadband connection failure, or other service disruption. 911 services may be limited in areas outside of the Verizon Wireless network. Not all public safety answering points have location-based E911 technology. Always be prepared to report your location to the 911 operator when placing an emergency call. Mobile phones operate using radio signals which cannot guarantee connection in all conditions.

Using Your Network Extender Near Other Electronic Devices

Most modern electronic equipment is shielded from radio frequency (RF) signals. However, RF signals from your Network Extender may affect inadequately shielded electronic equipment.

Conversely, ensure the unit is placed at least 2 feet away from products which generate electromagnetic radiation, such as a computer monitor or microwave oven.

Note: For the best care of your Network Extender, ensure that only authorized personnel service your device. Failure to do so may be dangerous and void your warranty. Consult the manufacturer of any personal medical devices, such as pacemakers and hearing aids, to determine if they are adequately shielded from external RF signals.

Radio Frequency (RF) Energy

Understanding How Your Network Extender Operates

Your Network Extender functions as a radio transmitter and receiver. When it is turned on, it receives and transmits radio frequency (RF) signals. When you use your Network Extender, the system handling your call controls the power level. This power can range from 1 microwatt to 50 milliwatts.

Knowing Radio Frequency Safety

The design of your Network Extender complies with updated NCRP standards described below:

In 1991–92, the Institute of Electrical and Electronics Engineers (IEEE) and the American National Standards Institute (ANSI) joined in updating ANSI's 1982 standard for safety levels with respect to human exposure to RF signals. More than 120 scientists, engineers and physicians from universities, government health agencies and industries developed this updated standard after reviewing the available body of research.

In 1993, the Federal Communications Commission (FCC) adopted this updated standard in a regulation. In August 1996, the FCC adopted a hybrid standard consisting of the existing ANSI/IEEE standard and the guidelines published by the National Council of Radiation Protection and Measurements (NCRP).

For more information about RF exposure, visit the FCC Web site at www.fcc.gov.

FCC Radio Frequency Emission

This device meets the FCC Radio Frequency Emission Guidelines.
FCC ID number: A3LSCS-26UC4.

FCC Statement

This product has been tested and complies with the specifications for a Class B digital device, pursuant to Part 15 of the FCC Rules. These limits are designed to provide reasonable protection against harmful interference in a residential installation. This equipment generates, uses, and can radiate radio frequency energy and, if not installed and used according to the instructions, may cause harmful interference to radio communications. However, there is no guarantee that interference will not occur in a particular installation. If this equipment does cause harmful interference to radio or television reception, which is found by turning the equipment off and on, the user is encouraged to try to correct the interference by one or more of the following measures:

- Reorient or relocate the receiving antenna.
- Increase the separation between the equipment and receiver.
- Connect the equipment into an outlet on a circuit different from that to which the receiver is connected.
- Consult the dealer or an experienced radio/TV technician for help.

This device complies with Part 15 of the FCC Rules. Operation is subject to the following two conditions: (1) This device may not cause harmful interference, and (2) This device must accept any interference received, including interference that may cause undesired operation.

FCC Caution: Any changes or modifications not expressly approved by the party responsible for compliance could void the user's authority to operate this equipment.

Important Note.

FCC Radiation Exposure Statement

To ensure the safety of users, the FCC has established criteria for the amount of radio frequency energy various products may produce depending on their intended usage. This product has been tested and found to comply with the FCC's exposure criteria.

This transmitter must not be co-located or operating in conjunction with any other antenna or transmitter.

The installation of the base unit should allow at least 20 centimeters between the base and persons to be in compliance with FCC RF exposure guidelines.

Please read the following important safety notices and instructions before installing or using the product.

- A DANGER warning refers to situations that could cause bodily injury.
 - A CAUTION warning refers to situations that could result in equipment malfunction or damage.
1. Follow all warnings and instructions marked on the product.
 2. Unplug this product from the wall outlet before cleaning. Do not use liquid cleaners or aerosol cleaners. Use an anti-static cleaning pad for cleaning.
 3. Do not use this product near water.
 4. Do not place this product on an unstable cart, stand or table. If the product falls, it could be seriously damaged.
 5. This product should be operated using the type of power indicated on the marking label. If you are not sure of the type of power available, consult your dealer or local power company.
 6. Do not allow anything to rest on the power cord. Do not locate this product where people will walk on the cord.

7. Never push objects of any kind into this product through cabinet slots as they may touch dangerous voltage points or short-out parts that could result in a fire or electric shock.
8. Never spill liquid of any kind into or onto the product.
9. Do not attempt to service this product yourself, as opening or removing covers may expose you to dangerous voltage points or other risks.
10. Refer all questions regarding servicing of this product to qualified service personnel.

Danger—Electric Shock and Fire

Electric current from power, telephone, and communication cables is hazardous, and could result in electric shock and/or fire.

To avoid electric shock, use caution when connecting cables. For example, do not connect safety extra-low voltage (SELV) circuits to telephone-network voltage (TNV) circuits. LAN ports contain SELV circuits, and WAN ports contain TNV circuits. Some LAN and WAN ports both use RJ-45 connectors.

To avoid electric shock, do not operate the product or connect or disconnect cables during electrical storms. To avoid electric shock, do not use this product in or near water.

To reduce the risk of fire or overheating, keep this product in well ventilated areas, away from radiators or other heat sources. Do not block cooling vents.

The plug-socket combination must be accessible at all times because it serves as the main power-disconnecting device.

Use only the manufacturer-provided AC adaptor approved for use with this product. Use of another AC adaptor may cause a fire or explosion.

This product relies on short-circuit (overcurrent) protection installed in your home or office. Ensure that a fuse or circuit breaker no larger than 120 VAC, 15A U.S. is used on the phase conductors (all current carrying conductors).

Unplug this product from the wall outlet and refer servicing to qualified service personnel under the following conditions:

- a. When the power cord or plug is damaged or frayed.
- b. If liquid has been spilled into the product.
- c. If the product has been exposed to rain or water.

- d. If the product does not operate normally when the operating instructions are followed. Adjust only those controls that are covered by the operating instructions, since improper adjustment of other controls may result in damage and will often require extensive work by a qualified technician to restore the product to normal condition.

Caution—Electromagnetic Interference

This product generates, uses, and can radiate radio frequency energy and, if not installed or used in accordance with the manufacturer's instruction manual, may cause interference with radio and television reception. This product has been tested and found to comply with the limits set forth in Part 15 of the Federal Communications Commission Rules.

Owner's Record

The model name, model number, regulatory number, and FCC ID are located on a label affixed to the bottom of the unit. The MSN and MAC ID are on a sticker affixed on the side of the unit. Record the MSN and the MAC ID in the space provided below. This will be helpful if you need to contact us about your Network Extender in the future.

Model: Verizon Wireless Network Extender

MSN:

MAC ID:

User Guide Proprietary Notice

CDMA Technology is licensed by QUALCOMM Incorporated under one or more of the following patents:

4,901,307 5,109,390 5,267,262 5,416,797

5,506,865 5,544,196 5,657,420 5,101,501

5,267,261 5,414,796 5,504,773 5,535,239

5,600,754 5,778,338 5,228,054 5,337,338

5,710,784 5,056,109 5,568,483 5,659,569

5,490,165 5,511,073

Section 6: Warranty Information

our Verizon Wireless Network Extender has been designed to provide reliable, worry-free service. If for any reason you have a problem with your equipment, please refer to the manufacturer's warranty in this section. For information regarding the terms and conditions of service for your Network Extender, please visit www.verizonwireless.com or call Verizon Wireless Customer Service at (800) 922-0204 or *611 from your Verizon Wireless mobile phone.

Standard Limited Warranty

What is Covered and For How Long?

SAMSUNG TELECOMMUNICATIONS AMERICA, LLC ("SAMSUNG") warrants to the original purchaser ("Purchaser") that SAMSUNG's Network Extender and accessories ("Products") included in this package are free from defects in material and workmanship under normal use and service for the period commencing upon the date of purchase and continuing for the following specified period of time after that date:

All components carry a one-year warranty.

What is Not Covered? This Limited Warranty is conditioned upon proper use of Product by Purchaser. This Limited Warranty does not cover: (a) defects or damage resulting from accident, misuse, abuse, neglect, unusual physical, electrical or electromechanical stress, or modification of any part of Product, including antenna, or cosmetic damage; (b) equipment that has the serial number removed or made illegible; (c) any plastic surfaces or other externally exposed parts that are scratched or damaged due to normal use; (d) malfunctions resulting from the use of Product in conjunction with accessories, products, or ancillary/peripheral equipment not furnished or approved by SAMSUNG; (e) defects or damage from improper testing, operation, maintenance, installation, or adjustment; (f) installation, maintenance, and service of Product, or (g) Product used or purchased outside the United States or Canada.

What are SAMSUNG's Obligations? During the applicable warranty period, SAMSUNG will repair or replace, at SAMSUNG's sole option, without charge to Purchaser, any defective component part of Product. To obtain service under this Limited Warranty, Purchaser must return Product to an authorized service facility in an adequate container for shipping, accompanied by Purchaser's sales receipt or comparable substitute proof of sale showing the date of purchase, the serial number of Product and the sellers'

name and address. To obtain assistance on where to deliver the Product, call Samsung Customer Care at 1-888-987-4357. Upon receipt, SAMSUNG will promptly repair or replace the defective Product.

SAMSUNG may, at SAMSUNG's sole option, use rebuilt, reconditioned, or new parts or components when repairing any Product or replace Product with a rebuilt, reconditioned or new Product. All other repaired/replaced Product will be warranted for a period equal to the remainder of the original Limited Warranty on the original Product or for 90 days, whichever is longer. All replaced parts, components, boards and equipment shall become the property of SAMSUNG. If SAMSUNG determines that any Product is not covered by this Limited Warranty, Purchaser must pay all parts, shipping, and labor charges for the repair or return of such Product.

WHAT ARE THE LIMITS ON SAMSUNG'S WARRANTY/LIABILITY?

EXCEPT AS SET FORTH IN THE EXPRESS WARRANTY CONTAINED HEREIN, PURCHASER TAKES THE PRODUCT "AS IS," AND SAMSUNG MAKES NO WARRANTY OR REPRESENTATION AND THERE ARE NO CONDITIONS, EXPRESS OR IMPLIED, STATUTORY OR OTHERWISE, OF ANY KIND WHATSOEVER WITH RESPECT TO THE PRODUCT, INCLUDING BUT NOT LIMITED TO:

"THE MERCHANTABILITY OF THE PRODUCT OR ITS FITNESS FOR ANY PARTICULAR PURPOSE OR USE;

"WARRANTIES OF TITLE OR NON-INFRINGEMENT;

"DESIGN, CONDITION, QUALITY, OR PERFORMANCE OF THE PRODUCT;

"THE WORKMANSHIP OF THE PRODUCT OR THE COMPONENTS CONTAINED THEREIN; OR

"COMPLIANCE OF THE PRODUCT WITH THE REQUIREMENTS OF ANY LAW, RULE, SPECIFICATION OR CONTRACT PERTAINING THERETO.

ALL IMPLIED WARRANTIES AND CONDITIONS THAT MAY ARISE BY OPERATION OF LAW, INCLUDING IF APPLICABLE THE IMPLIED WARRANTIES OF MERCHANTABILITY AND FITNESS FOR A PARTICULAR PURPOSE, ARE HEREBY LIMITED TO THE SAME DURATION OF TIME AS THE EXPRESS WRITTEN WARRANTY STATED HEREIN. SOME STATES/PROVINCES DO NOT ALLOW LIMITATIONS ON HOW LONG AN IMPLIED WARRANTY LASTS, SO THE ABOVE LIMITATION MAY NOT APPLY TO YOU. IN ADDITION, SAMSUNG SHALL NOT BE LIABLE FOR ANY DAMAGES OF ANY KIND RESULTING FROM THE PURCHASE, USE, OR MISUSE OF, OR INABILITY TO USE THE PRODUCT OR ARISING DIRECTLY OR INDIRECTLY FROM THE USE OR LOSS OF USE OF THE PRODUCT OR FROM THE BREACH OF THE EXPRESS WARRANTY, INCLUDING INCIDENTAL, SPECIAL, CONSEQUENTIAL OR SIMILAR DAMAGES, OR LOSS OF ANTICIPATED PROFITS OR BENEFITS, OR FOR DAMAGES ARISING FROM ANY TORT (INCLUDING NEGLIGENCE

OR GROSS NEGLIGENCE) OR FAULT COMMITTED BY SAMSUNG, ITS AGENTS OR EMPLOYEES, OR FOR ANY BREACH OF CONTRACT OR FOR ANY CLAIM BROUGHT AGAINST PURCHASER BY ANY OTHER PARTY. SOME STATES/PROVINCES DO NOT ALLOW THE EXCLUSION OR LIMITATION OF INCIDENTAL OR CONSEQUENTIAL DAMAGES, SO THE ABOVE LIMITATION OR EXCLUSION MAY NOT APPLY TO YOU. THIS WARRANTY GIVES YOU SPECIFIC LEGAL RIGHTS, AND YOU MAY ALSO HAVE OTHER RIGHTS, WHICH VARY FROM STATE TO STATE/PROVINCE TO PROVINCE. THIS LIMITED WARRANTY SHALL NOT EXTEND TO ANYONE OTHER THAN THE ORIGINAL PURCHASER OF THIS PRODUCT AND STATES PURCHASER'S EXCLUSIVE REMEDY. IF ANY PORTION OF THIS LIMITED WARRANTY IS HELD ILLEGAL OR UNENFORCEABLE BY REASON OF ANY LAW, SUCH PARTIAL ILLEGALITY OR UNENFORCEABILITY SHALL NOT AFFECT THE ENFORCEABILITY FOR THE REMAINDER OF THIS LIMITED WARRANTY WHICH PURCHASER ACKNOWLEDGES IS AND WILL ALWAYS BE CONSTRUED TO BE LIMITED BY ITS TERMS OR AS LIMITED AS THE LAW PERMITS. THE PARTIES UNDERSTAND THAT THE PURCHASER MAY USE THIRD-PARTY SOFTWARE OR EQUIPMENT IN CONJUNCTION WITH THE PRODUCT. SAMSUNG MAKES NO WARRANTIES OR REPRESENTATIONS AND THERE ARE NO CONDITIONS, EXPRESS OR IMPLIED, STATUTORY OR OTHERWISE, AS TO THE QUALITY, CAPABILITIES, OPERATIONS, PERFORMANCE OR SUITABILITY OF ANY THIRD-PARTY

SOFTWARE OR EQUIPMENT, WHETHER SUCH THIRD-PARTY SOFTWARE OR EQUIPMENT IS INCLUDED WITH THE PRODUCT DISTRIBUTED BY SAMSUNG OR OTHERWISE, INCLUDING THE ABILITY TO INTEGRATE ANY SUCH SOFTWARE OR EQUIPMENT WITH THE PRODUCT. THE QUALITY, CAPABILITIES, OPERATIONS, PERFORMANCE AND SUITABILITY OF ANY SUCH THIRD-PARTY SOFTWARE OR EQUIPMENT LIE SOLELY WITH THE PURCHASER AND THE DIRECT VENDOR, OWNER OR SUPPLIER OF SUCH THIRD-PARTY SOFTWARE OR EQUIPMENT, AS THE CASE MAY BE.

This Limited Warranty allocates risk of Product failure between Purchaser and SAMSUNG, and SAMSUNG's Product pricing reflects this allocation of risk and the limitations of liability contained in this Limited Warranty. The agents, employees, distributors, and dealers of SAMSUNG are not authorized to make modifications to this Limited Warranty, or make additional warranties binding on SAMSUNG.

Accordingly, additional statements such as dealer advertising or presentation, whether oral or written, do not constitute warranties by SAMSUNG and should not be relied upon.

End User License Agreement for Software

IMPORTANT. READ CAREFULLY: This End User License Agreement ("EULA") is a legal agreement between you (either an individual or a single entity) and Samsung Electronics Co., Ltd. for software owned by Samsung Electronics Co., Ltd. and its affiliated companies and its third party suppliers and licensors that accompanies this EULA, which includes computer software and may include associated media, printed materials, "online" or electronic documentation ("Software"). BY CLICKING THE "I ACCEPT" BUTTON (OR IF YOU BYPASS OR OTHERWISE DISABLE THE "I ACCEPT", AND STILL INSTALL, COPY, DOWNLOAD, ACCESS OR OTHERWISE USE THE SOFTWARE), YOU AGREE TO BE BOUND BY THE TERMS OF THIS EULA. IF YOU DO NOT ACCEPT THE TERMS IN THIS EULA, YOU MUST CLICK THE "DECLINE" BUTTON, DISCONTINUE USE OF THE SOFTWARE.

1. **GRANT OF LICENSE.** Samsung grants you the following rights provided that you comply with all terms and conditions of this EULA: You may install, use, access, display and run one copy of the Software on the local hard disk(s) or other permanent storage media of one computer and use the Software on a single computer or a mobile device at a time, and you may not make the Software available over a network where it could be used by multiple computers at the same time. You may make one copy of the Software in machine-readable form for backup purposes

only; provided that the backup copy must include all copyright or other proprietary notices contained on the original.

2. **RESERVATION OF RIGHTS AND OWNERSHIP.** Samsung reserves all rights not expressly granted to you in this EULA. The Software is protected by copyright and other intellectual property laws and treaties. Samsung or its suppliers own the title, copyright and other intellectual property rights in the Software. The Software is licensed, not sold.

3. **LIMITATIONS ON END USER RIGHTS.** You may not reverse engineer, decompile, disassemble, or otherwise attempt to discover the source code or algorithms of, the Software (except and only to the extent that such activity is expressly permitted by applicable law notwithstanding this limitation), or modify, or disable any features of, the Software, or create derivative works based on the Software. You may not rent, lease, lend, sublicense or provide commercial hosting services with the Software.

4. **CONSENT TO USE OF DATA.** You agree that Samsung and its affiliates may collect and use technical information gathered as part of the product support services related to the Software provided to you, if any, related to the Software. Samsung may use this information solely to improve its products or to provide customized services or technologies to you and will not disclose this information in a form that personally identifies you.

5. **UPGRADES.** This EULA applies to updates, supplements and add-on components (if any) of the Software that Samsung may provide to you or make available to you after the date you obtain your initial copy of the Software, unless we provide other terms along with such upgrade. To use Software identified as an upgrade, you must first be licensed for the Software identified by Samsung as eligible for the upgrade. After upgrading, you may no longer use the Software that formed the basis for your upgrade eligibility.

6. **SOFTWARE TRANSFER.** You may not transfer this EULA or the rights to the Software granted herein to any third party unless it is in connection with the sale of the mobile device which the Software accompanied. In such event, the transfer must include all of the Software (including all component parts, the media and printed materials, any upgrades, this EULA) and you may not retain any copies of the Software. The transfer may not be an indirect transfer, such as a consignment. Prior to the transfer, the end user receiving the Software must agree to all the EULA terms.

7. **EXPORT RESTRICTIONS.** You acknowledge that the Software is subject to export restrictions of various countries. You agree to comply with all applicable international and national laws that apply to the Software, including the U.S. Export Administration Regulations, as well as end user, end use, and destination restrictions issued by U.S. and other governments.

8. **TERMINATION.** This EULA is effective until terminated. Your rights under this License will terminate automatically without notice from Samsung if you fail to comply with any of the terms and conditions of this EULA. Upon termination of this EULA, you shall cease all use of the Software and destroy all copies, full or partial, of the Software.

9. **DISCLAIMER OF WARRANTIES.** You expressly acknowledge and agree that use of the Software is at your sole risk and that the entire risk as to satisfactory quality, performance, accuracy and effort is with you. TO THE MAXIMUM EXTENT PERMITTED BY APPLICABLE LAW, THE SOFTWARE IS PROVIDED "AS IS" AND WITH ALL FAULTS AND WITHOUT WARRANTY OF ANY KIND, AND SAMSUNG AND ITS LICENSORS (COLLECTIVELY REFERRED TO AS "SAMSUNG" FOR THE PURPOSES OF SECTIONS 9, 10 and 11) HEREBY DISCLAIM ALL WARRANTIES AND CONDITIONS WITH RESPECT TO THE SOFTWARE, EITHER EXPRESS, IMPLIED OR STATUTORY, INCLUDING, BUT NOT LIMITED TO, THE IMPLIED WARRANTIES AND/OR CONDITIONS OF MERCHANTABILITY, OF SATISFACTORY QUALITY OR WORKMANLIKE EFFORT, OF FITNESS FOR A PARTICULAR PURPOSE, OF RELIABILITY OR AVAILABILITY, OF ACCURACY, OF LACK OF VIRUSES, OF QUIET ENJOYMENT, AND NON-INFRINGEMENT OF THIRD PARTY RIGHTS. SAMSUNG DOES NOT WARRANT AGAINST INTERFERENCE WITH YOUR ENJOYMENT OF THE SOFTWARE, THAT THE FUNCTIONS CONTAINED IN THE SOFTWARE WILL MEET YOUR

REQUIREMENTS, THAT THE OPERATION OF THE SOFTWARE WILL BE UNINTERRUPTED OR ERROR-FREE, OR THAT DEFECTS IN THE SOFTWARE WILL BE CORRECTED. NO ORAL OR WRITTEN INFORMATION OR ADVICE GIVEN BY SAMSUNG OR A SAMSUNG AUTHORIZED REPRESENTATIVE SHALL CREATE A WARRANTY. SHOULD THE SOFTWARE PROVE DEFECTIVE, YOU ASSUME THE ENTIRE COST OF ALL NECESSARY SERVICING, REPAIR OR CORRECTION. SOME JURISDICTIONS DO NOT ALLOW THE EXCLUSION OF IMPLIED WARRANTIES OR LIMITATIONS ON APPLICABLE STATUTORY RIGHTS OF A CONSUMER, SO THESE EXCLUSIONS AND LIMITATIONS MAY NOT APPLY TO YOU.

10. EXCLUSION OF INCIDENTAL, CONSEQUENTIAL AND CERTAIN OTHER DAMAGES. TO THE EXTENT NOT PROHIBITED BY LAW, IN NO EVENT SHALL SAMSUNG BE LIABLE FOR PERSONAL INJURY, OR ANY INCIDENTAL, SPECIAL, INDIRECT OR CONSEQUENTIAL DAMAGES WHATSOEVER, OR FOR LOSS OF PROFITS, LOSS OF DATA, BUSINESS INTERRUPTION, OR FOR ANY PECUNIARY DAMAGES OR LOSSES, ARISING OUT OF OR RELATED TO YOUR USE OR INABILITY TO USE THE SOFTWARE, THE PROVISION OF OR FAILURE TO PROVIDE SUPPORT OR OTHER SERVICES, INFORMATION, SOFTWARE, AND RELATED CONTENT THROUGH THE SOFTWARE OR OTHERWISE ARISING OUT OF THE USE OF THE SOFTWARE, OR OTHERWISE UNDER OR IN CONNECTION WITH ANY PROVISION OF THIS EULA, HOWEVER CAUSED, REGARDLESS OF THE THEORY OF LIABILITY (CONTRACT, TORT

OR OTHERWISE) AND EVEN IF SAMSUNG HAS BEEN ADVISED OF THE POSSIBILITY OF SUCH DAMAGES. SOME JURISDICTIONS DO NOT ALLOW THE LIMITATION OF LIABILITY FOR PERSONAL INJURY, OR OF INCIDENTAL OR CONSEQUENTIAL DAMAGES, SO THIS LIMITATION MAY NOT APPLY TO YOU.

11. LIMITATION OF LIABILITY. Notwithstanding any damages that you might incur for any reason whatsoever (including, without limitation, all damages referenced herein and all direct or general damages in contract or anything else), the entire liability of Samsung under any provision of this EULA and your exclusive remedy hereunder shall be limited to the greater of the actual damages you incur in reasonable reliance on the Software up to the amount actually paid by you for the Software or US\$5.00. The foregoing limitations, exclusions and disclaimers (including Sections 9, 10 and 11) shall apply to the maximum extent permitted by applicable law, even if any remedy fails its essential purpose.

12. U.S. GOVERNMENT END USERS. The Software is licensed only with "restricted rights" and as "commercial items" consisting of "commercial software" and "commercial software documentation" with only those rights as are granted to all other end users pursuant to the terms and conditions herein.

13. APPLICABLE LAW. This EULA is governed by the laws of TEXAS, without regard to conflicts of laws principles. This EULA

shall not be governed by the UN Convention on Contracts for the International Sale of Goods, the application of which is expressly excluded. If a dispute, controversy or difference is not amicably settled, it shall be finally resolved by arbitration in Seoul, Korea in accordance with the Arbitration Rules of the Korean Commercial Arbitration Board. The award of arbitration shall be final and binding upon the parties.

14. ENTIRE AGREEMENT; SEVERABILITY. This EULA is the entire agreement between you and Samsung relating to the Software and supersedes all prior or contemporaneous oral or written communications, proposals and representations with respect to the Software or any other subject matter covered by this EULA. If any provision of this EULA is held to be void, invalid, unenforceable or illegal, the other provisions shall continue in full force and effect.

Open Source Announcement

Some software components of this product incorporate source code covered under open source licenses.

Acknowledgement:

This product includes software developed by the OpenSSL Project for use in the OpenSSL Toolkit (<http://www.openssl.org/>). The software included in this product contains copyrighted software that is licensed under the GPL/LGPL. You may obtain the complete Corresponding Source code from us for a period of

three years after our last shipment of this product by sending email to: nwswmanager@samsung.com.

If you want to obtain the complete Corresponding Source code in the physical medium such as CD-ROM, the cost of physically performing source distribution may be charged. You may also find a copy of the source at <http://www.samsungnetwork.com/Home/OpenSource>.

This offer is valid to anyone in receipt of this information. Below is the list of components covered under open source licenses.

Software	License	Software	License
apache	Apache License2.0	sed	GPL 2.0
mdnsresponder	APSL	stunnel	GPL 2.0
bsd-finger	BSD	sysklogd	GPL 2.0
ipsec-tools	BSD	systemd	GPL 2.0
mailx	BSD	sysvinit	GPL 2.0
netkit-base	BSD	tar	GPL 2.0
netkit-ftp	BSD	u-boot	GPL 2.0
netkit-telnet	BSD	udev	GPL 2.0
thttpd	BSD	watchdog	GPL 2.0

Software	License	Software	License
traceroute	BSD	wget	GPL 2.0
wpa_supplicant	BSD	which	GPL 2.0
adduser	GPL 2.0	xkbd	GPL 2.0
anacron	GPL 2.0	pam	GPL 2.0/BSD
at	GPL 2.0	util-linux	GPL 2.0/BSD
atm	GPL 2.0	binutils	GPL 2.0/ LGPL 2.1
autofs	GPL 2.0	gcc	GPL 2.0/ LGPL 2.1
base-passwd	GPL 2.0	procps	GPL 2.0/ LGPL 2.1
bash	GPL 2.0	mvultils	GPL 2.0/ Other
busybox	GPL 2.0	prelink	LGPL 2.1
console-tools	GPL 2.0	tslib	LGPL 2.1
coreutils	GPL 2.0	glibc	LGPL 2.1/ BSD
devfsd	GPL 2.0	putty	MIT License

Software	License	Software	License
dhcpcd	GPL 2.0	mvlttools	MontaVista Proprietary
e2fsprogs	GPL 2.0	pcmcia-cs	MPL/GPL 2.0
exim	GPL 2.0	openssl	OpenSSL
findutils	GPL 2.0	elfutils	OSL
gawk	GPL 2.0	bind	Other
GPS Device Driver	GPL 2.0	cracklib-libs	Other
grep	GPL 2.0	cron	Other
gzip	GPL 2.0	dhcp	Other
hostapd	GPL 2.0	file	Other
hostname	GPL 2.0	iputils	Other
ifupdown	GPL 2.0	libcap	Other
iptables	GPL 2.0	libpcap	Other
jed	GPL 2.0	libpcre	Other
ksymloops	GPL 2.0	libwww	Other

Software	License	Software	License
Linux kernel 2.6.10	GPL 2.0	linux-ftpd	Other
logrotate	GPL 2.0	makedev	Other
ltrace	GPL 2.0	net-snmp	Other
mDOC Block Device Driver	GPL 2.0	nis	Other
memstat	GPL 2.0	ntp	Other
mgetty	GPL 2.0	openssh	Other
module-init-tools	GPL 2.0	php4	Other
netbase	GPL 2.0	pidentd	Other
net-tools	GPL 2.0	portmap	Other
nfs-utils	GPL 2.0	radvd	Other
psmisc	GPL 2.0	shadow	Other
quota	GPL 2.0	tcpdump	Other
readline-libs	GPL 2.0	tcp-wrappers	Other
rpm	GPL 2.0	xinetd	Other

Software	License	Software	License
samba	GPL 2.0	zlib	Other
SB IPSEC 3.0	GPL 2.0	base-files-Mobilinux	Public Domain
schedutils	GPL 2.0	filesystem	Public Domain

* MontaVista Software, Inc. has provided the License information.

GNU GENERAL PUBLIC LICENSE

Version 2, June 1991 Copyright (C) 1989, 1991 Free Software Foundation, Inc. 51 Franklin St, Fifth Floor, Boston, MA 02110-1301 USA Everyone is permitted to copy and distribute verbatim copies of this license document, but changing it is not allowed.

Preamble

The licenses for most software are designed to take away your freedom to share and change it. By contrast, the GNU General Public License is intended to guarantee your freedom to share and change free software--to make sure the software is free for all its users. This General Public License applies to most of the Free Software Foundation's software and to any other program whose authors commit to using it. (Some other Free Software

Foundation software is covered by the GNU Library General Public License instead.) You can apply it to your programs, too.

When we speak of free software, we are referring to freedom, not price. Our General Public Licenses are designed to make sure that you have the freedom to distribute copies of free software (and charge for this service if you wish), that you receive source code or can get it if you want it, that you can change the software or use pieces of it in new free programs; and that you know you can do these things.

To protect your rights, we need to make restrictions that forbid anyone to deny you these rights or to ask you to surrender the rights. These restrictions translate to certain responsibilities for you if you distribute copies of the software, or if you modify it. For example, if you distribute copies of such a program, whether gratis or for a fee, you must give the recipients all the rights that you have. You must make sure that they, too, receive or can get the source code. And you must show them these terms so they know their rights.

We protect your rights with two steps: (1) copyright the software, and (2) offer you this license which gives you legal permission to copy, distribute and/or modify the software. Also, for each author's protection and ours, we want to make certain that everyone understands that there is no warranty for this free software. If the software is modified by someone else and passed

on, we want its recipients to know that what they have is not the original, so that any problems introduced by others will not reflect on the original authors' reputations.

Finally, any free program is threatened constantly by software patents. We wish to avoid the danger that redistributors of a free program will individually obtain patent licenses, in effect making the program proprietary. To prevent this, we have made it clear that any patent must be licensed for everyone's free use or not licensed at all. The precise terms and conditions for copying, distribution and modification follow.

TERMS AND CONDITIONS FOR COPYING, DISTRIBUTION AND MODIFICATION

0. This License applies to any program or other work which contains a notice placed by the copyright holder saying it may be distributed under the terms of this General Public License. The "Program", below, refers to any such program or work, and a "work based on the Program" means either the Program or any derivative work under copyright law: that is to say, a work containing the Program or a portion of it, either verbatim or with modifications and/or translated into another language. (Hereinafter, translation is included without limitation in the term "modification".) Each licensee is addressed as "you". Activities other than copying, distribution and modification are not covered by this License; they are outside its scope. The act of running the

Program is not restricted, and the output from the Program is covered only if its contents constitute a work based on the Program (independent of having been made by running the Program). Whether that is true depends on what the Program does.

1) You may copy and distribute verbatim copies of the Program's source code as you receive it, in any medium, provided that you conspicuously and appropriately publish on each copy an appropriate copyright notice and disclaimer of warranty; keep intact all the notices that refer to this License and to the absence of any warranty; and give any other recipients of the Program a copy of this License along with the Program. You may charge a fee for the physical act of transferring a copy, and you may at your option offer warranty protection in exchange for a fee.

2) You may modify your copy or copies of the Program or any portion of it, thus forming a work based on the Program, and copy and distribute such modifications or work under the terms of Section 1 above, provided that you also meet all of these conditions:

- a) You must cause the modified files to carry prominent notices stating that you changed the files and the date of any change.
- b) You must cause any work that you distribute or publish, that in whole or in part contains or is derived from the

Program or any part thereof, to be licensed as a whole at no charge to all third parties under the terms of this License.

- c) If the modified program normally reads commands interactively when run, you must cause it, when started running for such interactive use in the most ordinary way, to print or display an announcement including an appropriate copyright notice and a notice that there is no warranty (or else, saying that you provide a warranty) and that users may redistribute the program under these conditions, and telling the user how to view a copy of this License. (Exception: if the Program itself is interactive but does not normally print such an announcement, your work based on the Program is not required to print an announcement.)

These requirements apply to the modified work as a whole. If identifiable sections of that work are not derived from the Program, and can be reasonably considered independent and separate works in themselves, then this License, and its terms, do not apply to those sections when you distribute them as separate works. But when you distribute the same sections as part of a whole which is a work based on the Program, the distribution of the whole must be on the terms of this License, whose permissions for other licensees extend to the entire whole, and thus to each and every part regardless of who wrote it. Thus, it is not the intent of this section to claim rights or

contest your rights to work written entirely by you; rather, the intent is to exercise the right to control the distribution of derivative or collective works based on the Program. In addition, mere aggregation of another work not based on the Program with the Program (or with a work based on the Program) on a volume of a storage or distribution medium does not bring the other work under the scope of this License.

3. You may copy and distribute the Program (or a work based on it, under Section 2) in object code or executable form under the terms of Sections 1 and 2 above provided that you also do one of the following:

- a) Accompany it with the complete corresponding machine-readable source code, which must be distributed under the terms of Sections 1 and 2 above on a medium customarily used for software interchange; or,
- b) Accompany it with a written offer, valid for at least three years, to give any third party, for a charge no more than your cost of physically performing source distribution, a complete machine-readable copy of the corresponding source code, to be distributed under the terms of Sections 1 and 2 above on a medium customarily used for software interchange; or,
- c) Accompany it with the information you received as to the offer to distribute corresponding source code.

(This alternative is allowed only for noncommercial distribution and only if you received the program in object code or executable form with such an offer, in accord with Subsection b above.)

The source code for a work means the preferred form of the work for making modifications to it. For an executable work, complete source code means all the source code for all modules it contains, plus any associated interface definition files, plus the scripts used to control compilation and installation of the executable. However, as a special exception, the source code distributed need not include anything that is normally distributed (in either source or binary form) with the major components (compiler, kernel, and so on) of the operating system on which the executable runs, unless that component itself accompanies the executable. If distribution of executable or object code is made by offering access to copy from a designated place, then offering equivalent access to copy the source code from the same place counts as distribution of the source code, even though third parties are not compelled to copy the source along with the object code.

4. You may not copy, modify, sublicense, or distribute the Program except as expressly provided under this License. Any attempt otherwise to copy, modify, sublicense or distribute the Program is void, and will automatically terminate your rights under this License. However, parties who have received copies,

or rights, from you under this License will not have their licenses terminated so long as such parties remain in full compliance.

5. You are not required to accept this License, since you have not signed it. However, nothing else grants you permission to modify or distribute the Program or its derivative works. These actions are prohibited by law if you do not accept this License. Therefore, by modifying or distributing the Program (or any work based on the Program), you indicate your acceptance of this License to do so, and all its terms and conditions for copying, distributing or modifying the Program or works based on it.

6. Each time you redistribute the Program (or any work based on the Program), the recipient automatically receives a license from the original licensor to copy, distribute or modify the Program subject to these terms and conditions. You may not impose any further restrictions on the recipients' exercise of the rights granted herein. You are not responsible for enforcing compliance by third parties to this License.

7. If, as a consequence of a court judgment or allegation of patent infringement or for any other reason (not limited to patent issues), conditions are imposed on you (whether by court order, agreement or otherwise) that contradict the conditions of this License, they do not excuse you from the conditions of this License. If you cannot distribute so as to satisfy simultaneously your obligations under this License and any other pertinent

obligations, then as a consequence you may not distribute the Program at all. For example, if a patent license would not permit royalty-free redistribution of the Program by all those who receive copies directly or indirectly through you, then the only way you could satisfy both it and this License would be to refrain entirely from distribution of the Program. If any portion of this section is held invalid or unenforceable under any particular circumstance, the balance of the section is intended to apply and the section as a whole is intended to apply in other circumstances. It is not the purpose of this section to induce you to infringe any patents or other property right claims or to contest validity of any such claims; this section has the sole purpose of protecting the integrity of the free software distribution system, which is implemented by public license practices. Many people have made generous contributions to the wide range of software distributed through that system in reliance on consistent application of that system; it is up to the author/donor to decide if he or she is willing to distribute software through any other system and a licensee cannot impose that choice. This section is intended to make thoroughly clear what is believed to be a consequence of the rest of this License.

8. If the distribution and/or use of the Program is restricted in certain countries either by patents or by copyrighted interfaces, the original copyright holder who places the Program under this License may add an explicit geographical distribution limitation

excluding those countries, so that distribution is permitted only in or among countries not thus excluded. In such case, this License incorporates the limitation as if written in the body of this License.

9. The Free Software Foundation may publish revised and/or new versions of the General Public License from time to time. Such new versions will be similar in spirit to the present version, but may differ in detail to address new problems or concerns. Each version is given a distinguishing version number. If the Program specifies a version number of this License which applies to it and “any later version”, you have the option of following the terms and conditions either of that version or of any later version published by the Free Software Foundation. If the Program does not specify a version number of this License, you may choose any version ever published by the Free Software Foundation.

10. If you wish to incorporate parts of the Program into other free programs whose distribution conditions are different, write to the author to ask for permission. For software which is copyrighted by the Free Software Foundation, write to the Free Software Foundation; we sometimes make exceptions for this. Our decision will be guided by the two goals of preserving the free status of all derivatives of our free software and of promoting the sharing and reuse of software generally.

NO WARRANTY

11. BECAUSE THE PROGRAM IS LICENSED FREE OF CHARGE, THERE IS NO WARRANTY FOR THE PROGRAM, TO THE EXTENT PERMITTED BY APPLICABLE LAW. EXCEPT WHEN OTHERWISE STATED IN WRITING THE COPYRIGHT HOLDERS AND/OR OTHER PARTIES PROVIDE THE PROGRAM “AS IS” WITHOUT WARRANTY OF ANY KIND, EITHER EXPRESSED OR IMPLIED, INCLUDING, BUT NOT LIMITED TO, THE IMPLIED WARRANTIES OF MERCHANTABILITY AND FITNESS FOR A PARTICULAR PURPOSE. THE ENTIRE RISK AS TO THE QUALITY AND PERFORMANCE OF THE PROGRAM IS WITH YOU. SHOULD THE PROGRAM PROVE DEFECTIVE, YOU ASSUME THE COST OF ALL NECESSARY SERVICING, REPAIR OR CORRECTION. 12) IN NO EVENT UNLESS REQUIRED BY APPLICABLE LAW OR AGREED TO IN WRITING WILL ANY COPYRIGHT HOLDER, OR ANY OTHER PARTY WHO MAY MODIFY AND/OR REDISTRIBUTE THE PROGRAM AS PERMITTED ABOVE, BE LIABLE TO YOU FOR DAMAGES, INCLUDING ANY GENERAL, SPECIAL, INCIDENTAL OR CONSEQUENTIAL DAMAGES ARISING OUT OF THE USE OR INABILITY TO USE THE PROGRAM (INCLUDING BUT NOT LIMITED TO LOSS OF DATA OR DATA BEING RENDERED INACCURATE OR LOSSES SUSTAINED BY YOU OR THIRD PARTIES OR A FAILURE OF THE PROGRAM TO OPERATE WITH ANY OTHER PROGRAMS), EVEN IF SUCH HOLDER OR

OTHER PARTY HAS BEEN ADVISED OF THE POSSIBILITY OF SUCH DAMAGES.

END OF TERMS AND CONDITIONS

How to Apply These Terms to Your New Programs

If you develop a new program, and you want it to be of the greatest possible use to the public, the best way to achieve this is to make it free software which everyone can redistribute and change under these terms. To do so, attach the following notices to the program. It is safest to attach them to the start of each source file to most effectively convey the exclusion of warranty; and each file should have at least the “copyright” line and a pointer to where the full notice is found.

<one line to give the program's name and a brief idea of what it does.> Copyright (C) <year> <name of author>

This program is free software; you can redistribute it and/or modify it under the terms of the GNU General Public License as published by the Free Software Foundation; either version 2 of the License, or(at your option) any later version.

This program is distributed in the hope that it will be useful, but WITHOUT ANY WARRANTY; without even the implied warranty of MERCHANTABILITY or FITNESS FOR A PARTICULAR PURPOSE. See the GNU General Public License for more details.

You should have received a copy of the GNU General Public License along with this program; if not, write to the Free Software Foundation, Inc., 51 Franklin St, Fifth Floor, Boston, MA 02110-1301 USA.

Also add information on how to contact you by electronic and paper mail. If the program is interactive, make it output a short notice like this when it starts in an interactive mode:

Gnomovision version 69, Copyright (C) year name of author
Gnomovision comes with ABSOLUTELY NO WARRANTY; for details type 'show w'. This is free software, and you are welcome to redistribute it under certain conditions; type 'show c' for details.

The hypothetical commands 'show w' and 'show c' should show the appropriate parts of the General Public License. Of course, the commands you use may be called something other than 'show w' and 'show c'; they could even be mouse-clicks or menu

items--whatever suits your program. You should also get your employer (if you work as a programmer) or your school, if any, to sign a “copyright disclaimer” for the program, if necessary. Here is a sample; alter the names:

Yoyodyne, Inc., hereby disclaims all copyright interest in the program ‘Gnomovision’ (which makes passes at compilers) written by James Hacker. <signature of Ty Coon>, 1 April 1989 Ty Coon, President of Vice

This General Public License does not permit incorporating your program into proprietary programs. If your program is a subroutine library, you may consider it more useful to permit linking proprietary applications with the library. If this is what you want to do, use the GNU Lesser General Public License instead of this License.

GNU GENERAL PUBLIC LICENSE

Version 2.1, February 1999 Copyright (C) 1991, 1999 Free Software Foundation, Inc. 51 Franklin Street, Fifth Floor, Boston, MA 02110-1301 USA Everyone is permitted to copy and distribute verbatim copies of this license document, but changing it is not allowed.

[This is the first released version of the Lesser GPL. It also counts as the successor of the GNU Library Public License, version 2, hence the version number 2.1.]

Preamble

The licenses for most software are designed to take away your freedom to share and change it. By contrast, the GNU General Public Licenses are intended to guarantee your freedom to share and change free software--to make sure the software is free for all its users.

This license, the Lesser General Public License, applies to some specially designated software packages-- typically libraries--of the Free Software Foundation and other authors who decide to use it. You can use it too, but we suggest you first think carefully about whether this license or the ordinary General Public License is the better strategy to use in any particular case, based on the explanations below. When we speak of free software, we are referring to freedom of use, not price. Our General Public Licenses are designed to make sure that you have the freedom to distribute copies of free software (and charge for this service if you wish); that you receive source code or can get it if you want it; that you can change the software and use pieces of it in new free programs; and that you are informed that you can do these things. To protect your rights, we need to make restrictions that forbid distributors to deny you these rights or to ask you to surrender these rights. These restrictions translate to certain responsibilities for you if you distribute copies of the library or if you modify it. For example, if you distribute copies of the library, whether gratis or for a fee, you must give the recipients all the

rights that we gave you. You must make sure that they, too, receive or can get the source code. If you link other code with the library, you must provide complete object files to the recipients, so that they can relink them with the library after making changes to the library and recompiling it. And you must show them these terms so they know their rights.

We protect your rights with a two-step method: (1) we copyright the library, and (2) we offer you this license, which gives you legal permission to copy, distribute and/or modify the library. To protect each distributor, we want to make it very clear that there is no warranty for the free library. Also, if the library is modified by someone else and passed on, the recipients should know that what they have is not the original version, so that the original author's reputation will not be affected by problems that might be introduced by others. Finally, software patents pose a constant threat to the existence of any free program. We wish to make sure that a company cannot effectively restrict the users of a free program by obtaining a restrictive license from a patent holder. Therefore, we insist that any patent license obtained for a version of the library must be consistent with the full freedom of use specified in this license. Most GNU software, including some libraries, is covered by the ordinary GNU General Public License. This license, the GNU Lesser General Public License, applies to certain designated libraries, and is quite different from the ordinary General Public License. We use this license for certain

libraries in order to permit linking those libraries into non-free programs. When a program is linked with a library, whether statically or using a shared library, the combination of the two is legally speaking a combined work, a derivative of the original library. The ordinary General Public License therefore permits such linking only if the entire combination fits its criteria of freedom. The Lesser General Public License permits more lax criteria for linking other code with the library.

We call this license the “Lesser” General Public License because it does Less to protect the user's freedom than the ordinary General Public License. It also provides other free software developers Less of an advantage over competing non-free programs. These disadvantages are the reason we use the ordinary General Public License for many libraries. However, the Lesser license provides advantages in certain special circumstances. For example, on rare occasions, there may be a special need to encourage the widest possible use of a certain library, so that it becomes a de-facto standard. To achieve this, non-free programs must be allowed to use the library. A more frequent case is that a free library does the same job as widely used non-free libraries. In this case, there is little to gain by limiting the free library to free software only, so we use the Lesser General Public License.

In other cases, permission to use a particular library in non-free programs enables a greater number of people to use a large body

of free software. For example, permission to use the GNU C Library in non-free programs enables many more people to use the whole GNU operating system, as well as its variant, the GNU/Linux operating system.

Although the Lesser General Public License is Less protective of the users' freedom, it does ensure that the user of a program that is linked with the Library has the freedom and the wherewithal to run that program using a modified version of the Library. The precise terms and conditions for copying, distribution and modification follow. Pay close attention to the difference between a "work based on the library" and a "work that uses the library". The former contains code derived from the library, whereas the latter must be combined with the library in order to run.

TERMS AND CONDITIONS FOR COPYING, DISTRIBUTION AND MODIFICATION

0. This License Agreement applies to any software library or other program which contains a notice placed by the copyright holder or other authorized party saying it may be distributed under the terms of this Lesser General Public License (also called "this License"). Each licensee is addressed as "you". A "library" means a collection of software functions and/or data prepared so as to be conveniently linked with application programs (which use some of those functions and data) to form executables. The "Library", below, refers to any such software library or work

which has been distributed under these terms. A "work based on the Library" means either the Library or any derivative work under copyright law: that is to say, a work containing the Library or a portion of it, either verbatim or with modifications and/or translated straightforwardly into another language. (Hereinafter, translation is included without limitation in the term "modification".)

"Source code" for a work means the preferred form of the work for making modifications to it. For a library, complete source code means all the source code for all modules it contains, plus any associated interface definition files, plus the scripts used to control compilation and installation of the library. Activities other than copying, distribution and modification are not covered by this License; they are outside its scope. The act of running a program using the Library is not restricted, and output from such a program is covered only if its contents constitute a work based on the Library (independent of the use of the Library in a tool for writing it). Whether that is true depends on what the Library does and what the program that uses the Library does.

1. You may copy and distribute verbatim copies of the Library's complete source code as you receive it, in any medium, provided that you conspicuously and appropriately publish on each copy an appropriate copyright notice and disclaimer of warranty; keep intact all the notices that refer to this License and to the absence of any warranty; and distribute a copy of this License along with

the Library. You may charge a fee for the physical act of transferring a copy, and you may at your option offer warranty protection in exchange for a fee.

2. You may modify your copy or copies of the Library or any portion of it, thus forming a work based on the Library, and copy and distribute such modifications or work under the terms of Section 1 above, provided that you also meet all of these conditions:

- a) The modified work must itself be a software library.
- b) You must cause the files modified to carry prominent notices stating that you changed the files and the date of any change.
- c) You must cause the whole of the work to be licensed at no charge to all third parties under the terms of this License.
- d) If a facility in the modified Library refers to a function or a table of data to be supplied by an application program that uses the facility, other than as an argument passed when the facility is invoked, then you must make a good faith effort to ensure that, in the event an application does not supply such function or table, the facility still operates, and performs whatever part of its purpose remains meaningful. (For example, a function in a library to compute square roots has a purpose that is entirely well-defined independent of the application. Therefore,

Subsection 2d requires that any application-supplied function or table used by this function must be optional: if the application does not supply it, the square root function must still compute square roots.) These requirements apply to the modified work as a whole. If identifiable sections of that work are not derived from the Library, and can be reasonably considered independent and separate works in themselves, then this License, and its terms, do not apply to those sections when you distribute them as separate works. But when you distribute the same sections as part of a whole which is a work based on the Library, the distribution of the whole must be on the terms of this License, whose permissions for other licensees extend to the entire whole, and thus to each and every part regardless of who wrote it. Thus, it is not the intent of this section to claim rights or contest your rights to work written entirely by you; rather, the intent is to exercise the right to control the distribution of derivative or collective works based on the Library. In addition, mere aggregation of another work not based on the Library with the Library (or with a work based on the Library) on a volume of a storage or distribution medium does not bring the other work under the scope of this License.

3. You may opt to apply the terms of the ordinary GNU General Public License instead of this License to a given copy of the Library. To do this, you must alter all the notices that refer to this License, so that they refer to the ordinary GNU General Public License, version 2, instead of to this License. (If a newer version than version 2 of the ordinary GNU General Public License has appeared, then you can specify that version instead if you wish.) Do not make any other change in these notices. Once this change is made in a given copy, it is irreversible for that copy, so the ordinary GNU General Public License applies to all subsequent copies and derivative works made from that copy. This option is useful when you wish to copy part of the code of the Library into a program that is not a library.

4. You may copy and distribute the Library (or a portion or derivative of it, under Section 2) in object code or executable form under the terms of Sections 1 and 2 above provided that you accompany it with the complete corresponding machine-readable source code, which must be distributed under the terms of Sections 1 and 2 above on a medium customarily used for software interchange. If distribution of object code is made by offering access to copy from a designated place, then offering equivalent access to copy the source code from the same place satisfies the requirement to distribute the source code, even though third parties are not compelled to copy the source along with the object code.

5. A program that contains no derivative of any portion of the Library, but is designed to work with the Library by being compiled or linked with it, is called a “work that uses the Library”. Such a work, in isolation, is not a derivative work of the Library, and therefore falls outside the scope of this License. However, linking a “work that uses the Library” with the Library creates an executable that is a derivative of the Library (because it contains portions of the Library), rather than a “work that uses the library”. The executable is therefore covered by this License. Section 6 states terms for distribution of such executables.

When a “work that uses the Library” uses material from a header file that is part of the Library, the object code for the work may be a derivative work of the Library even though the source code is not. Whether this is true is especially significant if the work can be linked without the Library, or if the work is itself a library. The threshold for this to be true is not precisely defined by law. If such an object file uses only numerical parameters, data structure layouts and accessors, and small macros and small inline functions (ten lines or less in length), then the use of the object file is unrestricted, regardless of whether it is legally a derivative work. (Executables containing this object code plus portions of the Library will still fall under Section 6.) Otherwise, if the work is a derivative of the Library, you may distribute the object code for the work under the terms of Section 6. Any

executables containing that work also fall under Section 6, whether or not they are linked directly with the Library itself.

6. As an exception to the Sections above, you may also combine or link a “work that uses the Library” with the Library to produce a work containing portions of the Library, and distribute that work under terms of your choice, provided that the terms permit modification of the work for the customer’s own use and reverse engineering for debugging such modifications. You must give prominent notice with each copy of the work that the Library is used in it and that the Library and its use are covered by this License. You must supply a copy of this License. If the work during execution displays copyright notices, you must include the copyright notice for the Library among them, as well as a reference directing the user to the copy of this License. Also, you must do one of these things:

a) Accompany the work with the complete corresponding machine-readable source code for the Library including whatever changes were used in the work (which must be distributed under Sections 1 and 2 above); and, if the work is an executable linked with the Library, with the complete machine-readable “work that uses the Library”, as object code and/or source code, so that the user can modify the Library and then relink to produce a modified executable containing the modified Library. (It is understood that the user who changes the contents of definitions files

in the Library will not necessarily be able to recompile the application to use the modified definitions.)

- b) Use a suitable shared library mechanism for linking with the Library. A suitable mechanism is one that (1) uses at run time a copy of the library already present on the user’s computer system, rather than copying library functions into the executable, and (2) will operate properly with a modified version of the library, if the user installs one, as long as the modified version is interface-compatible with the version that the work was made with.
- c) Accompany the work with a written offer, valid for at least three years, to give the same user the materials specified in Subsection 6a, above, for a charge no more than the cost of performing this distribution. d) If distribution of the work is made by offering access to copy from a designated place, offer equivalent access to copy the above specified materials from the same place. e) Verify that the user has already received a copy of these materials or that you have already sent this user a copy. For an executable, the required form of the “work that uses the Library” must include any data and utility programs needed for reproducing the executable from it. However, as a special exception, the materials to be distributed need not include anything that is normally distributed (in either source or binary form) with the major components (compiler, kernel,

and so on) of the operating system on which the executable runs, unless that component itself accompanies the executable.

It may happen that this requirement contradicts the license restrictions of other proprietary libraries that do not normally accompany the operating system. Such a contradiction means you cannot use both them and the Library together in an executable that you distribute.

7. You may place library facilities that are a work based on the Library side-by-side in a single library together with other library facilities not covered by this License, and distribute such a combined library, provided that the separate distribution of the work based on the Library and of the other library facilities is otherwise permitted, and provided that you do these two things:

- a) Accompany the combined library with a copy of the same work based on the Library, uncombined with any other library facilities. This must be distributed under the terms of the Sections above.
- b) Give prominent notice with the combined library of the fact that part of it is a work based on the Library, and explaining where to find the accompanying uncombined form of the same work.

8. You may not copy, modify, sublicense, link with, or distribute the Library except as expressly provided under this License. Any

attempt otherwise to copy, modify, sublicense, link with, or distribute the Library is void, and will automatically terminate your rights under this License. However, parties who have received copies, or rights, from you under this License will not have their licenses terminated so long as such parties remain in full compliance.

9. You are not required to accept this License, since you have not signed it. However, nothing else grants you permission to modify or distribute the Library or its derivative works. These actions are prohibited by law if you do not accept this License. Therefore, by modifying or distributing the Library (or any work based on the Library), you indicate your acceptance of this License to do so, and all its terms and conditions for copying, distributing or modifying the Library or works based on it.

10. Each time you redistribute the Library (or any work based on the Library), the recipient automatically receives a license from the original licensor to copy, distribute, link with or modify the Library subject to these terms and conditions. You may not impose any further restrictions on the recipients' exercise of the rights granted herein. You are not responsible for enforcing compliance by third parties with this License.

11. If, as a consequence of a court judgment or allegation of patent infringement or for any other reason (not limited to patent issues), conditions are imposed on you (whether by court order,

agreement or otherwise) that contradict the conditions of this License, they do not excuse you from the conditions of this License. If you cannot distribute so as to satisfy simultaneously your obligations under this License and any other pertinent obligations, then as a consequence you may not distribute the Library at all. For example, if a patent license would not permit royalty-free redistribution of the Library by all those who receive copies directly or indirectly through you, then the only way you could satisfy both it and this License would be to refrain entirely from distribution of the Library. If any portion of this section is held invalid or unenforceable under any particular circumstance, the balance of the section is intended to apply, and the section as a whole is intended to apply in other circumstances. It is not the purpose of this section to induce you to infringe any patents or other property right claims or to contest validity of any such claims; this section has the sole purpose of protecting the integrity of the free software distribution system which is implemented by public license practices. Many people have made generous contributions to the wide range of software distributed through that system in reliance on consistent application of that system; it is up to the author/donor to decide if he or she is willing to distribute software through any other system and a licensee cannot impose that choice. This section is intended to make thoroughly clear what is believed to be a consequence of the rest of this License.

12. If the distribution and/or use of the Library is restricted in certain countries either by patents or by copyrighted interfaces, the original copyright holder who places the Library under this License may add an explicit geographical distribution limitation excluding those countries, so that distribution is permitted only in or among countries not thus excluded. In such case, this License incorporates the limitation as if written in the body of this License.

13. The Free Software Foundation may publish revised and/or new versions of the Lesser General Public License from time to time. Such new versions will be similar in spirit to the present version, but may differ in detail to address new problems or concerns. Each version is given a distinguishing version number. If the Library specifies a version number of this License which applies to it and “any later version”, you have the option of following the terms and conditions either of that version or of any later version published by the Free Software Foundation. If the Library does not specify a license version number, you may choose any version ever published by the Free Software Foundation.

14. If you wish to incorporate parts of the Library into other free programs whose distribution conditions are incompatible with these, write to the author to ask for permission. For software which is copyrighted by the Free Software Foundation, write to the Free Software Foundation; we sometimes make exceptions

for this. Our decision will be guided by the two goals of preserving the free status of all derivatives of our free software and of promoting the sharing and reuse of software generally.

NO WARRANTY

15. BECAUSE THE LIBRARY IS LICENSED FREE OF CHARGE, THERE IS NO WARRANTY FOR THE LIBRARY, TO THE EXTENT PERMITTED BY APPLICABLE LAW. EXCEPT WHEN OTHERWISE STATED IN WRITING THE COPYRIGHT HOLDERS AND/OR OTHER PARTIES PROVIDE THE LIBRARY "AS IS" WITHOUT WARRANTY OF ANY KIND, EITHER EXPRESSED OR IMPLIED, INCLUDING, BUT NOT LIMITED TO, THE IMPLIED WARRANTIES OF MERCHANTABILITY AND FITNESS FOR A PARTICULAR PURPOSE. THE ENTIRE RISK AS TO THE QUALITY AND PERFORMANCE OF THE LIBRARY IS WITH YOU. SHOULD THE LIBRARY PROVE DEFECTIVE, YOU ASSUME THE COST OF ALL NECESSARY SERVICING, REPAIR OR CORRECTION.

16. IN NO EVENT UNLESS REQUIRED BY APPLICABLE LAW OR AGREED TO IN WRITING WILL ANY COPYRIGHT HOLDER, OR ANY OTHER PARTY WHO MAY MODIFY AND/OR REDISTRIBUTE THE LIBRARY AS PERMITTED ABOVE, BE LIABLE TO YOU FOR DAMAGES, INCLUDING ANY GENERAL, SPECIAL, INCIDENTAL OR CONSEQUENTIAL DAMAGES ARISING OUT OF THE USE OR INABILITY TO USE THE LIBRARY (INCLUDING BUT NOT LIMITED TO LOSS OF DATA OR DATA BEING RENDERED INACCURATE OR

LOSSES SUSTAINED BY YOU OR THIRD PARTIES OR A FAILURE OF THE LIBRARY TO OPERATE WITH ANY OTHER SOFTWARE), EVEN IF SUCH HOLDER OR OTHER PARTY HAS BEEN ADVISED OF THE POSSIBILITY OF SUCH DAMAGES.

END OF TERMS AND CONDITIONS

How to Apply These Terms to Your New Programs

If you develop a new library, and you want it to be of the greatest possible use to the public, we recommend making it free software that everyone can redistribute and change. You can do so by permitting redistribution under these terms (or, alternatively, under the terms of the ordinary General Public License). To apply these terms, attach the following notices to the library. It is safest to attach them to the start of each source file to most effectively convey the exclusion of warranty; and each file should have at least the "copyright" line and a pointer to where the full notice is found.

one line to give the library's name and an idea of what it does.

Copyright (C) year name of author.

This library is free software; you can redistribute it and/or modify it under the terms of the GNU Lesser General Public License as published by the Free Software Foundation; either version 2.1 of the License, or (at your option) any later version.

This library is distributed in the hope that it will be useful, but WITHOUT ANY WARRANTY; without even the implied warranty of MERCHANTABILITY or FITNESS FOR A PARTICULAR PURPOSE. See the GNU Lesser General Public License for more details.

You should have received a copy of the GNU Lesser General Public License along with this library; if not, write to the Free Software Foundation, Inc., 51 Franklin Street, Fifth Floor, Boston, MA 02110-1301 USA.

Also add information on how to contact you by electronic and paper mail. You should also get your employer (if you work as a programmer) or your school, if any, to sign a "copyright disclaimer" for the library, if necessary. Here is a sample; alter the names:

Yoyodyne, Inc., hereby disclaims all copyright interest in the library 'Frob' (a library for tweaking knobs) written by James Random Hacker.

Signature of Ty Coon, 1 April 1990 Ty Coon, President of Vice

That's all there is to it!

Apache License

Version 2.0, January 2004

<http://www.apache.org/licenses/>

TERMS AND CONDITIONS FOR USE, REPRODUCTION, AND DISTRIBUTION

1. Definitions.

"License" shall mean the terms and conditions for use, reproduction, and distribution as defined by Sections 1 through 9 of this document.

"Licensor" shall mean the copyright owner or entity authorized by the copyright owner that is granting the License.

"Legal Entity" shall mean the union of the acting entity and all other entities that control, are controlled by, or are under common control with that entity. For the purposes of this definition, "control" means (i) the power, direct or indirect, to cause the direction or management of such entity, whether by

contract or otherwise, or (ii) ownership of fifty percent (50%) or more of the outstanding shares, or (iii) beneficial ownership of such entity. "

"You" (or "Your") shall mean an individual or Legal Entity exercising permissions granted by this License.

"Source" form shall mean the preferred form for making modifications, including but not limited to software source code, documentation source, and configuration files.

"Object" form shall mean any form resulting from mechanical transformation or translation of a Source form, including but not limited to compiled object code, generated documentation, and conversions to other media types.

"Work" shall mean the work of authorship, whether in Source or Object form, made available under the License, as indicated by a copyright notice that is included in or attached to the work (an example is provided in the Appendix below).

"Derivative Works" shall mean any work, whether in Source or Object form, that is based on (or derived from) the Work and for which the editorial revisions, annotations, elaborations, or other modifications represent, as a whole, an original work of authorship. For the purposes of this License, Derivative Works shall not include works that remain separable from, or merely link (or bind by name) to the interfaces of, the Work and Derivative Works thereof.

"Contribution" shall mean any work of authorship, including the

original version of the Work and any modifications or additions to that Work or Derivative Works thereof, that is intentionally submitted to Licensor for inclusion in the Work by the copyright owner or by an individual or Legal Entity authorized to submit on behalf of the copyright owner. For the purposes of this definition, "submitted" means any form of electronic, verbal, or written communication sent to the Licensor or its representatives, including but not limited to communication on electronic mailing lists, source code control systems, and issue tracking systems that are managed by, or on behalf of, the Licensor for the purpose of discussing and improving the Work, but excluding communication that is conspicuously marked or otherwise designated in writing by the copyright owner as "Not a Contribution."

"Contributor" shall mean Licensor and any individual or Legal Entity on behalf of whom a Contribution has been received by Licensor and subsequently incorporated within the Work.

2. Grant of Copyright License. Subject to the terms and conditions of this License, each Contributor hereby grants to You a perpetual, worldwide, non-exclusive, no-charge, royalty-free, irrevocable copyright license to reproduce, prepare Derivative Works of, publicly display, publicly perform, sublicense, and distribute the Work and such Derivative Works in Source or Object form.

3. Grant of Patent License. Subject to the terms and conditions of this License, each Contributor hereby grants to You a perpetual, worldwide, non-exclusive, no-charge, royalty-free, irrevocable (except as stated in this section) patent license to make, have made, use, offer to sell, sell, import, and otherwise transfer the Work, where such license applies only to those patent claims licensable by such Contributor that are necessarily infringed by their Contribution(s) alone or by combination of their Contribution(s) with the Work to which such Contribution(s) was submitted. If You institute patent litigation against any entity (including a cross-claim or counterclaim in a lawsuit) alleging that the Work or a Contribution incorporated within the Work constitutes direct or contributory patent infringement, then any patent licenses granted to You under this License for that Work shall terminate as of the date such litigation is filed.

4. Redistribution. You may reproduce and distribute copies of the Work or Derivative Works thereof in any medium, with or without modifications, and in Source or Object form, provided that You meet the following conditions:

1. You must give any other recipients of the Work or Derivative Works a copy of this License; and
2. You must cause any modified files to carry prominent notices stating that You changed the files; and

3. You must retain, in the Source form of any Derivative Works that You distribute, all copyright, patent, trademark, and attribution notices from the Source form of the Work, excluding those notices that do not pertain to any part of the Derivative Works; and
4. If the Work includes a "NOTICE" text file as part of its distribution, then any Derivative Works that You distribute must include a readable copy of the attribution notices contained within such NOTICE file, excluding those notices that do not pertain to any part of the Derivative Works, in at least one of the following places: within a NOTICE text file distributed as part of the Derivative Works; within the Source form or documentation, if provided along with the Derivative Works; or, within a display generated by the Derivative Works, if and wherever such third-party notices normally appear. The contents of the NOTICE file are for informational purposes only and do not modify the License. You may add Your own attribution notices within Derivative Works that You distribute, alongside or as an addendum to

the NOTICE text from the Work, provided that such additional attribution notices cannot be construed as modifying the License.

You may add Your own copyright statement to Your modifications and may provide additional or different license terms and conditions for use, reproduction, or distribution of Your modifications, or for any such Derivative Works as a whole, provided Your use, reproduction, and distribution of the Work otherwise complies with the conditions stated in this License.

5. **Submission of Contributions.** Unless You explicitly state otherwise, any Contribution intentionally submitted for inclusion in the Work by You to the Licensor shall be under the terms and conditions of this License, without any additional terms or conditions. Notwithstanding the above, nothing herein shall supersede or modify the terms of any separate license agreement you may have executed with Licensor regarding such Contributions.

6. **Trademarks.** This License does not grant permission to use the trade names, trademarks, service marks, or product names of the Licensor, except as required for reasonable and customary use in describing the origin of the Work and reproducing the content of the NOTICE file.
7. **Disclaimer of Warranty.** Unless required by applicable law or agreed to in writing, Licensor provides the Work (and each Contributor provides its Contributions) on an "AS IS" BASIS, WITHOUT WARRANTIES OR CONDITIONS OF ANY KIND, either express or implied, including, without limitation, any warranties or conditions of TITLE, NON-INFRINGEMENT, MERCHANTABILITY, or FITNESS FOR A PARTICULAR PURPOSE. You are solely responsible for determining the appropriateness of using or redistributing the Work and assume any risks associated with Your exercise of permissions under this License.
8. **Limitation of Liability.** In no event and under no legal theory, whether in tort (including negligence), contract, or otherwise, unless required by applicable law (such as deliberate and grossly negligent acts) or agreed to in writing, shall any Contributor be liable to You for damages,

including any direct, indirect, special, incidental, or consequential damages of any character arising as a result of this License or out of the use or inability to use the Work (including but not limited to damages for loss of goodwill, work stoppage, computer failure or malfunction, or any and all other commercial damages or losses), even if such Contributor has been advised of the possibility of such damages.

9. **Accepting Warranty or Additional Liability.** While redistributing the Work or Derivative Works thereof, You may choose to offer, and charge a fee for, acceptance of support, warranty, indemnity, or other liability obligations and/or rights consistent with this License. However, in accepting such obligations, You may act only on Your own behalf and on Your sole responsibility, not on behalf of any other Contributor, and only if You agree to indemnify, defend, and hold each Contributor harmless for any liability incurred by, or claims asserted against, such Contributor by reason of your accepting any such warranty or additional liability.

END OF TERMS AND CONDITIONS

BSD 2.0 License

Redistribution and use in source and binary forms, with or without modification, are permitted provided that the following conditions are met:

1. Redistributions of source code must retain the above copyright notice, this list of conditions and the following disclaimer.
2. Redistributions in binary form must reproduce the above copyright notice, this list of conditions and the following disclaimer in the documentation and/or other materials provided with the distribution.
3. Neither the name of the <ORGANIZATION> nor the names of its contributors may be used to endorse or promote products derived from this software without specific prior written permission.

THIS SOFTWARE IS PROVIDED BY THE COPYRIGHT HOLDERS AND CONTRIBUTORS "AS IS" AND ANY EXPRESS OR IMPLIED WARRANTIES, INCLUDING, BUT NOT LIMITED TO, THE IMPLIED WARRANTIES OF MERCHANTABILITY AND FITNESS FOR A PARTICULAR PURPOSE ARE DISCLAIMED. IN NO EVENT SHALL THE COPYRIGHT OWNER OR CONTRIBUTORS BE LIABLE FOR ANY DIRECT, INDIRECT, INCIDENTAL, SPECIAL, EXEMPLARY, OR

CONSEQUENTIAL DAMAGES (INCLUDING, BUT NOT LIMITED TO, PROCUREMENT OF SUBSTITUTE GOODS OR SERVICES; LOSS OF USE, DATA, OR PROFITS; OR BUSINESS INTERRUPTION) HOWEVER CAUSED AND ON ANY THEORY OF LIABILITY, WHETHER IN CONTRACT, STRICT LIABILITY, OR TORT (INCLUDING NEGLIGENCE OR OTHERWISE) ARISING IN ANY WAY OUT OF THE USE OF THIS SOFTWARE, EVEN IF ADVISED OF THE POSSIBILITY OF SUCH DAMAGE.

OpenSSL

Copyright (c) 1998-2003 The OpenSSL Project. All rights reserved.

Redistribution and use in source and binary forms, with or without modification, are permitted provided that the following conditions are met:

1. Redistributions of source code must retain the above copyright notice, this list of conditions and the following disclaimer.
2. Redistributions in binary form must reproduce the above copyright notice, this list of conditions and the following disclaimer in the documentation and/or other materials provided with the distribution.

3. All advertising materials mentioning features or use of this software must display the following acknowledgment: This product includes software developed by the OpenSSL Project for use in the OpenSSL Toolkit.
<http://www.openssl.org>
4. The names "OpenSSL Toolkit" and "OpenSSL Project" must not be used to endorse or promote products derived from this software without prior written permission. For written permission, please contact openssl-core@openssl.org.
5. Products derived from this software may not be called "OpenSSL" nor may "OpenSSL" appear in their names without prior written permission of the OpenSSL Project.
6. Redistributions of any form whatsoever must retain the following acknowledgment: "This product includes software developed by the OpenSSL Project for use in the OpenSSL Toolkit (<http://www.openssl.org>)."

THIS SOFTWARE IS PROVIDED BY THE OpenSSL PROJECT "AS IS" AND ANY EXPRESSED OR IMPLIED WARRANTIES, INCLUDING, BUT NOT LIMITED TO, THE IMPLIED WARRANTIES OF MERCHANTABILITY AND FITNESS FOR A PARTICULAR PURPOSE

ARE DISCLAIMED. IN NO EVENT SHALL THE OpenSSL PROJECT OR ITS CONTRIBUTORS BE LIABLE FOR ANY DIRECT, INDIRECT, INCIDENTAL, SPECIAL, EXEMPLARY, OR CONSEQUENTIAL DAMAGES (INCLUDING, BUT NOT LIMITED TO, PROCUREMENT OF SUBSTITUTE GOODS OR SERVICES; LOSS OF USE, DATA, OR PROFITS; OR BUSINESS INTERRUPTION) HOWEVER CAUSED AND ON ANY THEORY OF LIABILITY, WHETHER IN CONTRACT, STRICT LIABILITY, OR TORT (INCLUDING NEGLIGENCE OR OTHERWISE) ARISING IN ANY WAY OUT OF THE USE OF THIS SOFTWARE, EVEN IF ADVISED OF THE POSSIBILITY OF SUCH DAMAGE. This product includes cryptographic software written by Eric Young (eay@cryptsoft.com). This product includes software written by Tim Hudson (tjh@cryptsoft.com).

APPLE PUBLIC SOURCE LICENSE

Version 2.0 - August 6, 2003

Please read this License carefully before downloading this software. By downloading or using this software, you are agreeing to be bound by the terms of this License. If you do not or cannot agree to the terms of this License, please do not download or use the software.

1. General; Definitions. This License applies to any program or other work which Apple Computer, Inc. ("Apple") makes publicly available and which contains a notice placed by Apple identifying such program or work as "Original Code" and stating that it is

subject to the terms of this Apple Public Source License version 2.0 ("License"). As used in this License:

1.1 "Applicable Patent Rights" mean: (a) in the case where Apple is the grantor of rights, (i) claims of patents that are now or hereafter acquired, owned by or assigned to Apple and (ii) that cover subject matter contained in the Original Code, but only to the extent necessary to use, reproduce and/or distribute the Original Code without infringement; and (b) in the case where You are the grantor of rights, (i) claims of patents that are now or hereafter acquired, owned by or assigned to You and (ii) that cover subject matter in Your Modifications, taken alone or in combination with Original Code.

1.2 "Contributor" means any person or entity that creates or contributes to the creation of Modifications.

1.3 "Covered Code" means the Original Code, Modifications, the combination of Original Code and any Modifications, and/or any respective portions thereof.

1.4 "Externally Deploy" means: (a) to sublicense, distribute or otherwise make Covered Code available, directly or indirectly, to anyone other than You; and/or (b) to use Covered Code, alone or as part of a Larger Work, in any way to provide a service, including but not limited to delivery of content, through electronic communication with a client other than You.

1.5 "Larger Work" means a work which combines Covered Code or portions thereof with code not governed by the terms of this License.

1.6 "Modifications" mean any addition to, deletion from, and/or change to, the substance and/or structure of the Original Code, any previous Modifications, the combination of Original Code and any previous Modifications, and/or any respective portions thereof. When code is released as a series of files, a Modification is: (a) any addition to or deletion from the contents of a file containing Covered Code; and/or (b) any new file or other representation of computer program statements that contains any part of Covered Code.

1.7 "Original Code" means (a) the Source Code of a program or other work as originally made available by Apple under this License, including the Source Code of any updates or upgrades to such programs or works made available by Apple under this License, and that has been expressly identified by Apple as such in the header file(s) of such work; and (b) the object code compiled from such Source Code and originally made available by Apple under this License.

1.8 "Source Code" means the human readable form of a program or other work that is suitable for making modifications to it, including all modules it contains, plus any associated interface

definition files, scripts used to control compilation and installation of an executable (object code).

1.9 "You" or "Your" means an individual or a legal entity exercising rights under this License. For legal entities, "You" or "Your" includes any entity which controls, is controlled by, or is under common control with, You, where "control" means (a) the power, direct or indirect, to cause the direction or management of such entity, whether by contract or otherwise, or (b) ownership of fifty percent (50%) or more of the outstanding shares or beneficial ownership of such entity.

2. Permitted Uses; Conditions & Restrictions. Subject to the terms and conditions of this License, Apple hereby grants You, effective on the date You accept this License and download the Original Code, a world-wide, royalty-free, non-exclusive license, to the extent of Apple's Applicable Patent Rights and copyrights covering the Original Code, to do the following:

2.1 Unmodified Code. You may use, reproduce, display, perform, internally distribute within Your organization, and Externally Deploy verbatim, unmodified copies of the Original Code, for commercial or non-commercial purposes, provided that in each instance: (a) You must retain and reproduce in all copies of Original Code the copyright and other proprietary notices and disclaimers of Apple as they appear in the Original Code, and keep intact all notices in the Original Code that refer to this

License; and (b) You must include a copy of this License with every copy of Source Code of Covered Code and documentation You distribute or Externally Deploy, and You may not offer or impose any terms on such Source Code that alter or restrict this License or the recipients' rights hereunder, except as permitted under Section 6.

2.2 Modified Code. You may modify Covered Code and use, reproduce, display, perform, internally distribute within Your organization, and Externally Deploy Your Modifications and Covered Code, for commercial or non-commercial purposes, provided that in each instance You also meet all of these conditions: (a) You must satisfy all the conditions of Section 2.1 with respect to the Source Code of the Covered Code; (b) You must duplicate, to the extent it does not already exist, the notice in Exhibit A in each file of the Source Code of all Your Modifications, and cause the modified files to carry prominent notices stating that You changed the files and the date of any change; and (c) If You Externally Deploy Your Modifications, You must make Source Code of all Your Externally Deployed Modifications either available to those to whom You have Externally Deployed Your Modifications, or publicly available. Source Code of Your Externally Deployed Modifications must be released under the terms set forth in this License, including the license grants set forth in Section 3 below, for as long as you Externally Deploy the Covered Code or twelve (12) months from

the date of initial External Deployment, whichever is longer. You should preferably distribute the Source Code of Your Externally Deployed Modifications electronically (e.g. download from a web site).

2.3 Distribution of Executable Versions. In addition, if You Externally Deploy Covered Code (Original Code and/or Modifications) in object code, executable form only, You must include a prominent notice, in the code itself as well as in related documentation, stating that Source Code of the Covered Code is available under the terms of this License with information on how and where to obtain such Source Code.

2.4 Third Party Rights. You expressly acknowledge and agree that although Apple and each Contributor grants the licenses to their respective portions of the Covered Code set forth herein, no assurances are provided by Apple or any Contributor that the Covered Code does not infringe the patent or other intellectual property rights of any other entity. Apple and each Contributor disclaim any liability to You for claims brought by any other entity based on infringement of intellectual property rights or otherwise. As a condition to exercising the rights and licenses granted hereunder, You hereby assume sole responsibility to secure any other intellectual property rights needed, if any. For example, if a third party patent license is required to allow You to distribute the Covered Code, it is Your responsibility to acquire that license before distributing the Covered Code.

3. Your Grants. In consideration of, and as a condition to, the licenses granted to You under this License, You hereby grant to any person or entity receiving or distributing Covered Code under this License a non-exclusive, royalty-free, perpetual, irrevocable license, under Your Applicable Patent Rights and other intellectual property rights (other than patent) owned or controlled by You, to use, reproduce, display, perform, modify, sublicense, distribute and Externally Deploy Your Modifications of the same scope and extent as Apple's licenses under Sections 2.1 and 2.2 above.

4. Larger Works. You may create a Larger Work by combining Covered Code with other code not governed by the terms of this License and distribute the Larger Work as a single product. In each such instance, You must make sure the requirements of this License are fulfilled for the Covered Code or any portion thereof.

5. Limitations on Patent License. Except as expressly stated in Section 2, no other patent rights, express or implied, are granted by Apple herein. Modifications and/or Larger Works may require additional patent licenses from Apple which Apple may grant in its sole discretion.

6. Additional Terms. You may choose to offer, and to charge a fee for, warranty, support, indemnity or liability obligations and/or other rights consistent with the scope of the license granted herein ("Additional Terms") to one or more recipients of Covered

Code. However, You may do so only on Your own behalf and as Your sole responsibility, and not on behalf of Apple or any Contributor. You must obtain the recipient's agreement that any such Additional Terms are offered by You alone, and You hereby agree to indemnify, defend and hold Apple and every Contributor harmless for any liability incurred by or claims asserted against Apple or such Contributor by reason of any such Additional Terms.

7. Versions of the License. Apple may publish revised and/or new versions of this License from time to time. Each version will be given a distinguishing version number. Once Original Code has been published under a particular version of this License, You may continue to use it under the terms of that version. You may also choose to use such Original Code under the terms of any subsequent version of this License published by Apple. No one other than Apple has the right to modify the terms applicable to Covered Code created under this License.

8. NO WARRANTY OR SUPPORT. The Covered Code may contain in whole or in part pre-release, untested, or not fully tested works. The Covered Code may contain errors that could cause failures or loss of data, and may be incomplete or contain inaccuracies. You expressly acknowledge and agree that use of the Covered Code, or any portion thereof, is at Your sole and entire risk. THE COVERED CODE IS PROVIDED "AS IS" AND WITHOUT WARRANTY, UPGRADES OR SUPPORT OF ANY KIND

AND APPLE AND APPLE'S LICENSOR(S) (COLLECTIVELY REFERRED TO AS "APPLE" FOR THE PURPOSES OF SECTIONS 8 AND 9) AND ALL CONTRIBUTORS EXPRESSLY DISCLAIM ALL WARRANTIES AND/OR CONDITIONS, EXPRESS OR IMPLIED, INCLUDING, BUT NOT LIMITED TO, THE IMPLIED WARRANTIES AND/OR CONDITIONS OF MERCHANTABILITY, OF SATISFACTORY QUALITY, OF FITNESS FOR A PARTICULAR PURPOSE, OF ACCURACY, OF QUIET ENJOYMENT, AND NONINFRINGEMENT OF THIRD PARTY RIGHTS. APPLE AND EACH CONTRIBUTOR DOES NOT WARRANT AGAINST INTERFERENCE WITH YOUR ENJOYMENT OF THE COVERED CODE, THAT THE FUNCTIONS CONTAINED IN THE COVERED CODE WILL MEET YOUR REQUIREMENTS, THAT THE OPERATION OF THE COVERED CODE WILL BE UNINTERRUPTED OR ERROR-FREE, OR THAT DEFECTS IN THE COVERED CODE WILL BE CORRECTED. NO ORAL OR WRITTEN INFORMATION OR ADVICE GIVEN BY APPLE, AN APPLE AUTHORIZED REPRESENTATIVE OR ANY CONTRIBUTOR SHALL CREATE A WARRANTY. You acknowledge that the Covered Code is not intended for use in the operation of nuclear facilities, aircraft navigation, communication systems, or air traffic control machines in which case the failure of the Covered Code could lead to death, personal injury, or severe physical or environmental damage.

9. LIMITATION OF LIABILITY. TO THE EXTENT NOT PROHIBITED BY LAW, IN NO EVENT SHALL APPLE OR ANY CONTRIBUTOR BE

LIABLE FOR ANY INCIDENTAL, SPECIAL, INDIRECT OR CONSEQUENTIAL DAMAGES ARISING OUT OF OR RELATING TO THIS LICENSE OR YOUR USE OR INABILITY TO USE THE COVERED CODE, OR ANY PORTION THEREOF, WHETHER UNDER A THEORY OF CONTRACT, WARRANTY, TORT (INCLUDING NEGLIGENCE), PRODUCTS LIABILITY OR OTHERWISE, EVEN IF APPLE OR SUCH CONTRIBUTOR HAS BEEN ADVISED OF THE POSSIBILITY OF SUCH DAMAGES AND NOTWITHSTANDING THE FAILURE OF ESSENTIAL PURPOSE OF ANY REMEDY. SOME JURISDICTIONS DO NOT ALLOW THE LIMITATION OF LIABILITY OF INCIDENTAL OR CONSEQUENTIAL DAMAGES, SO THIS LIMITATION MAY NOT APPLY TO YOU. In no event shall Apple's total liability to You for all damages (other than as may be required by applicable law) under this License exceed the amount of fifty dollars (\$50.00).

10. Trademarks. This License does not grant any rights to use the trademarks or trade names "Apple", "Apple Computer", "Mac", "Mac OS", "QuickTime", "QuickTime Streaming Server" or any other trademarks, service marks, logos or trade names belonging to Apple (collectively "Apple Marks") or to any trademark, service mark, logo or trade name belonging to any Contributor. You agree not to use any Apple Marks in or as part of the name of products derived from the Original Code or to endorse or promote products derived from the Original Code other than as expressly permitted by and in strict compliance at all times with Apple's third party

trademark usage guidelines which are posted at eudora="autourl"><http://www.apple.com/legal/guidelinesfor3rdparties.html>.

11. Ownership. Subject to the licenses granted under this License, each Contributor retains all rights, title and interest in and to any Modifications made by such Contributor. Apple retains all rights, title and interest in and to the Original Code and any Modifications made by or on behalf of Apple ("Apple Modifications"), and such Apple Modifications will not be automatically subject to this License. Apple may, at its sole discretion, choose to license such Apple Modifications under this License, or on different terms from those contained in this License or may choose not to license them at all.

12. Termination.

12.1 Termination. This License and the rights granted hereunder will terminate: (a) automatically without notice from Apple if You fail to comply with any term(s) of this License and fail to cure such breach within 30 days of becoming aware of such breach; (b) immediately in the event of the circumstances described in Section 13.5(b); or (c) automatically without notice from Apple if You, at any time during the term of this License, commence an action for patent infringement against Apple; provided that Apple did not first commence an action for patent infringement against You in that instance.

12.2 Effect of Termination. Upon termination, You agree to immediately stop any further use, reproduction, modification, sublicensing and distribution of the Covered Code. All sublicenses to the Covered Code which have been properly granted prior to termination shall survive any termination of this License. Provisions which, by their nature, should remain in effect beyond the termination of this License shall survive, including but not limited to Sections 3, 5, 8, 9, 10, 11, 12.2 and 13. No party will be liable to any other for compensation, indemnity or damages of any sort solely as a result of terminating this License in accordance with its terms, and termination of this License will be without prejudice to any other right or remedy of any party.

13. Miscellaneous.

13.1 Government End Users. The Covered Code is a "commercial item" as defined in FAR 2.101. Government software and technical data rights in the Covered Code include only those rights customarily provided to the public as defined in this License. This customary commercial license in technical data and software is provided in accordance with FAR 12.211 (Technical Data) and 12.212 (Computer Software) and, for Department of Defense purchases, DFAR 252.227-7015 (Technical Data -- Commercial Items) and 227.7202-3 (Rights in Commercial Computer Software or Computer Software

Documentation). Accordingly, all U.S. Government End Users acquire Covered Code with only those rights set forth herein.

13.2 Relationship of Parties. This License will not be construed as creating an agency, partnership, joint venture or any other form of legal association between or among You, Apple or any Contributor, and You will not represent to the contrary, whether expressly, by implication, appearance or otherwise.

13.3 Independent Development. Nothing in this License will impair Apple's right to acquire, license, develop, have others develop for it, market and/or distribute technology or products that perform the same or similar functions as, or otherwise compete with, Modifications, Larger Works, technology or products that You may develop, produce, market or distribute.

13.4 Waiver; Construction. Failure by Apple or any Contributor to enforce any provision of this License will not be deemed a waiver of future enforcement of that or any other provision. Any law or regulation which provides that the language of a contract shall be construed against the drafter will not apply to this License.

13.5 Severability. (a) If for any reason a court of competent jurisdiction finds any provision of this License, or portion thereof, to be unenforceable, that provision of the License will be enforced to the maximum extent permissible so as to effect the economic benefits and intent of the parties, and the remainder of this License will continue in full force and effect. (b)

Notwithstanding the foregoing, if applicable law prohibits or restricts You from fully and/or specifically complying with Sections 2 and/or 3 or prevents the enforceability of either of those Sections, this License will immediately terminate and You must immediately discontinue any use of the Covered Code and destroy all copies of it that are in your possession or control.

13.6 Dispute Resolution. Any litigation or other dispute resolution between You and Apple relating to this License shall take place in the Northern District of California, and You and Apple hereby consent to the personal jurisdiction of, and venue in, the state and federal courts within that District with respect to this License. The application of the United Nations Convention on Contracts for the International Sale of Goods is expressly excluded.

13.7 Entire Agreement; Governing Law. This License constitutes the entire agreement between the parties with respect to the subject matter hereof. This License shall be governed by the laws of the United States and the State of California, except that body of California law concerning conflicts of law.

Where You are located in the province of Quebec, Canada, the following clause applies: The parties hereby confirm that they have requested that this License and all related documents be drafted in English. Les parties ont exigé que le présent contrat et tous les documents connexes soient rédigés en anglais.

EXHIBIT A.

"Portions Copyright (c) 1999-2003 Apple Computer, Inc. All Rights Reserved.

This file contains Original Code and/or Modifications of Original Code as defined in and that are subject to the Apple Public Source License Version 2.0 (the 'License'). You may not use this file except in compliance with the License. Please obtain a copy of the License at <http://www.opensource.apple.com/apsl/> and read it before using this file.

The Original Code and all software distributed under the License are distributed on an 'AS IS' basis, WITHOUT WARRANTY OF ANY KIND, EITHER EXPRESS OR IMPLIED, AND APPLE HEREBY DISCLAIMS ALL SUCH WARRANTIES, INCLUDING WITHOUT LIMITATION, ANY WARRANTIES OF MERCHANTABILITY, FITNESS FOR A PARTICULAR PURPOSE, QUIET ENJOYMENT OR NON-INFRINGEMENT. Please see the License for the specific language governing rights and limitations under the License."

Precautions for Transfer and Disposal

If data stored on this device is deleted or reformatted using the standard methods, the data only appears to be removed on a superficial level, and it may be possible for someone to retrieve and reuse the data by means of special software.

To avoid unintended information leaks and other problems of this sort, it is recommended that the device be returned to Samsung's Customer Care Center for an Extended File System (EFS) Clear which will eliminate all user memory and return all settings to default settings. Please contact the **Samsung Customer Care Center** for details.

Important! Please provide warranty information (proof of purchase) to Samsung's Customer Care Center in order to provide this service at no charge. If the warranty has expired on the device, charges may apply.

Customer Care Center:

1000 Klein Rd.

Plano, TX 75074

Toll Free Tel: 1.888.987.HELP (4357)

Samsung Telecommunications America, LLC:

1301 East Lookout Drive

Richardson, Texas 75082

Phone: 1-800-SAMSUNG (726-7864)

Important! If you are using a handset other than a standard numeric keypad, dial the numbers listed in brackets.

Phone: 1-888-987-HELP (4357)

©2010 Samsung Telecommunications America. All rights reserved.

No reproduction in whole or in part allowed without prior written approval. Specifications and availability subject to change without notice.

Index

A
Activation 8
Antenna 13

C

Components
 Front View 9
 Rear View 10

E

E911 7

G

Getting Started 2
 Activating Your Device 3

GPS Antenna
 Installation 13
 Mini-coax Connector 14
 Port 14

H

Heat Vents 10

L

LED
 GPS 9
 Power 9

 System 9
 WAN 9

M

Maintenance Notes 12

N

Network Extender
 Basics 9
 Features 12
 Front View 9
 Rear View 10

O

Open Source
 Apache License 49
 BSD 2.0 License 53
 OpenSSL 54

P

Port
 DC 12V Power 10
 GPS Antenna 10
 WAN 11

S

Standard Limited Warranty
 25

U

Understanding Your Device 6

W

Warranty Information 25